



Private Brands Domestic Importer Vendor Business Requirements

Updated April 12, 2022

Formerly known as Belk Vendor Guide, Belk Best Plan

This document, including any and all attachments, contains information or material proprietary to Belk and, unless approved in advance and in writing by Belk's authorized designee, this document and its content may not be provided or disclosed, in whole or in part, to any person or entity other than the intended recipient. Such recipient shall use this document, the information and/or material provided herewith, solely for the purpose of designing, developing, proposing or providing merchandise ordered, or to be potentially ordered, by Belk for sale on-line, on mobile apps, in printed offer or in its retail stores. If you have received this document in error, please immediately return it to the sender and delete it from any document storage system.

Thank you for taking the time to read the Belk Private Brands Domestic Importer Vendor Business Requirements. You have been selected as a supplier for Belk's exclusive Private Brands. As a Domestic Importer, you will be acting as Importer of Record for the purchase orders placed with your company. Please review the information in this guide to become familiar with what Belk holds vendors accountable for. This manual is supplemental to, and each vendor is required to comply with, the other guidelines, codes, policies, and procedures issued by Belk from time to time, as identified on www.Belk.com under Vendor Resources, including the Belk Private Brands Code of Conduct (all of which form part of Belk's Vendor Compliance program). It is critical that the requirements within this guide are followed by all of our vendor partners so that Belk can continue to provide our customers with the best possible retail experience. Our success in doing this is dependent on you and we recognize, appreciate, and greatly value your partnership!

Best Regards,

Belk Vendor Compliance Team



DATE	SECTION	CHANGE
5/1/2017	ALL	Published New Guide
11/1/2017	6.2	Belk no longer requires sizers on hangers (*excluding kids*) - please do not use!
7/20/18	2.1-2.6	Vendor Terms and Conditions including Private Brands Code of Conduct, Restricted Countries of Production and California Proposition 65 regulations
7/20/18	9.2	Routing must now be completed 72 hours prior to pick up
7/20/18	2.1-2.6	Vendor Terms and Conditions including Private Brands Code of Conduct, Restricted Countries of Production and California Proposition 65 regulations
7/20/18	11.2	Terms and Conditions of Payment
10/10/18	4.2	Prop 65 Attribute Must be Done in GXS
10/10/18	6.2	Hanger Sizer Now required- newborn to 8-20 and children's 7-16
10/10/18	6.8	Lithium Battery Warning Label
11/30/18	9.3	Transportation pick up time change- 12pm on day of shipment request
5/1/19	6.5.6	UPC barcoded sticker for Ecom must be UPC-A or EAN 13
5/1/19	2.5	Office of Foreign Assets Control statement (OFAC)
7/1/19	4.2	Country of Origin must be entered at time of set-up in GSX
9/4/19	6.3	Belk's RN # 31104 must be used on all Belk Private Brands
11/15/19	Appendix B	Revised Hanger Requirements
11/15/19	7.5	LTL Shipments must be on pallets, Truckloads should continue to be floor loaded.
11/15/19	9.2	LTL shipments must now be palletized, Truckload shipments need to be floor loaded.
1/13/20	8.2	Transplace I # / Load # in ASN
1/13/20	8.6	Use of Transplace BOL
7/30/20	2.7	Add section 2.7 - Insurance
11/17/2020	2.7, 8.4, 9.1, 9.2, 9.3	Edit Section 2.7, 2nd and 3rd bullets. Edit email address in Section 8.4, 9.1, 9.2 and 9.3
12/11/2020	Section 6, 7.0	Section 6, 7.0 – RFID. Section 8.1, 8.2 and 9.2
1/25/2021	Section 7.2	Edit carton dimensions
5/17/2021	2.2.1, 2.2.5, 3.3 & Appendix A, 4.6, 6.5.3, 6.10.4, 12.1, Appendix G	Update on Forced Labor, Restricted Countries of Production, Force Majeure Section 3.3 4 th bullet & Appendix A, Section 3, Section 4.6 final paragraph, eCommerce Reshippable Packaging Dimensions, RFID Chart II addition, RC 101 through 106 & Appendix G
6/17/2021	6.6, 12.1 & 14.1	Fine Jewelry – update on PO and Ecommerce Fulfillment Shipping Address and Repairs, Returns and Damages Shipping Address. Update RC codes.
8/4/2021	12.1	Revise chargeback rates for a few RC codes.
8/19/2021	6.10.4	Add RFID placement guidelines in Soft Home and Hard Home
8/24/2021	6.2, Appendix B, Appendix H	Update section 6.2 Hanger Requirements, Update Appendix B, Add Appendix H



10/26/2021	6.10, 8.6 through 9.4, 12.1 & Appendix I	Update section 6.10 RFID Requirements, Update Section 8.3 through 9.4, Update Section 12.1 & Add Appendix I
01/07/2022	12.1	Update chargeback table verbiage
04/12/2022	4.6, 14.1 and 14.2	Update to Product Testing and Final Inspection Protocols, Update to GXS-OpenText Contact. Update shipping address for Fine Jewelry and What Goes Around Comes Around

Table of Contents

1.1 New Vendor Onboarding	8
1.2 Supplier Direct Fulfillment (SDF) New Vendor Onboarding	8
1.3 Vendor Information	8
Section Two: Vendor Terms and Conditions	8
2.1 Acceptable Business Practices	8
2.2 Code of Conduct	9
2.2.1 Human Rights	9
2.2.2 Sustainability	11
2.2.3 Terms of Implementation	13
2.2.4 Consequences of Non-Compliance	13
2.2.5 Restricted Countries of Production	13
2.2.6 Declaration	14
2.3 Confidentiality	15
2.4 Disposition of Merchandise	15
2.5 California Proposition 65	15
2.6 Vendor Compliance	16
2.7 Insurance	18
Section Three: Purchase Orders	19
3.1 Purchase Order Types	19
3.2 Purchase Order Requirements and Restrictions	19
3.3 Terms and Conditions of Purchase Orders	19
Section Four: Product Information	21
4.1 UPC Item Set Up	21
4.2 GXS Items Set Up	22
4.3 Extended Attributes	22
4.4 Image Standards	22
4.5 eCommerce Sample Requirements	23
4.6 Private Brands Color, Technical Design, and Quality Assurance	23
Section Five: EDI Requirements	24
5.1 EDI Requirements	24
5.2 EDI Terms and Conditions	24
Section Six: Product Preparation	24

6.1 UPC Merchandise Ticketing Standards	24
6.3 General Product Packaging Requirements	27
6.4 STORE ONLY Packaging Requirements	27
6.5 ECOMMERCE ONLY Packing Requirements	27
6.5.1 eCommerce Individual Packaging	27
6.5.2 eCommerce Single SKU Cartons	28
6.5.3 eCommerce Reshippable Packaging	28
6.5.4 eCommerce Category/Department specific eCommerce requirements:	29
6.5.5 eCommerce Polybag Specifications	31
6.5.6 eCommerce UPC Barcoded Sticker Requirements	31
6.6 Fine Jewelry Ticketing & Packing Requirements	32
6.7 Gift with Purchase (GWP) Packing Requirements	32
6.8 Lithium Battery Warning Label	32
6.9 Supplier Direct Fulfillment Packaging Requirements	32
6.10 RFID	33
6.10.1 RFID Basic	33
6.10.2 Belk Mandate	33
6.10.3 Account Setup and Contact Info	34
6.10.4 Hangtags/Stickers and Lead Times	34
6.10.5 Storage and Handling for RFID	37
Section Seven: Shipment Preparations	37
7.1 Carton Packing Requirements	37
7.2 Carton Dimensions	38
7.3 Carton Labels	38
7.4 Material Restrictions	39
Section Eight: Shipping Standards	39
8.1 Ship Date Expectations	39
8.2 ASN Standards	40
8.3 Ship One Time Per Purchase Order	40
8.4 Shipment of Hazardous Materials	40
8.5 Port of Entry Shipments	40
8.6 Bill of Lading (BOL) Requirements	40
Section Nine: Routing Guide	41



9.1 Transportation Managements System and TMS Vendor Sup Up	41
9.2 Routing Requirements	41
9.3 Shipment Charges	43
9.4 Transportation Vendor Expense Sharing.....	44
Section Ten: Returns to Vendor	45
10.1 Damaged Merchandise	45
10.2 Defective Merchandise	45
10.3 Unsold Merchandise	45
10.4 Returns to Vendors	45
Section Eleven: Accounts Payable	45
11.1 Invoices	45
11.2 Terms and Conditions of Payment	45
11.3 Accounts Payable Vendor Web Portal.....	46
Section Twelve: Vendor Chargebacks.....	46
12.1 Chargeback Table	46
12.2 Chargeback Inquiries and Disputes	49
12.3 Chargeback Dispute Requirements	50
Section Thirteen: Payment Information	50
13.1 Payment Remittance Details	50
13.2 Outstanding Invoice Verification	50
Section Fourteen: Key Contact Information.....	50
14.1 Belk Contact Information	50
14.2 Belk Recommended Suppliers	51
Appendix A: Terms and Conditions of Purchase Order	52
Appendix B: Hanger Specifications	55
Appendix C: Example of Store Packing.....	58
Appendix D: Reshippable Carton Requirements.....	59
Appendix E: Ecommerce Folding Guidelines	60
Appendix F: Vendor & Factory Profile	62
Appendix G: Vendor Recordkeeping Requirements	63
Appendix H: Mainetti Contact List.....	66
Appendix I: RFID Tag and Sticker Catalog.....	67



Section One: Vendor Information

1.1 New Vendor Onboarding

For new vendor onboarding questions, please email VendorRelations@Belk.com.

1.2 Supplier Direct Fulfillment (SDF) New Vendor Onboarding

Please see the Drop Ship Participant Policies document for details regarding the Belk Drop Ship program, available on [www.belk.com/vendor/resources/Drop Ship Documents/Drop Ship Participant Policies](http://www.belk.com/vendor/resources/Drop%20Ship%20Documents/Drop%20Ship%20Participant%20Policies). The Drop Ship program has different policies and procedures than purchase orders going into Belk stores and/or fulfillment centers. For new Drop Ship vendor onboarding questions, please email SDFvendorcare@belk.com.

1.3 Vendor Information

Belk should be notified of any changes in company information including company name, address, change in shipping points, or any other pertinent information in order to keep systems and records up to-date. Please email all company changes to VendorRelations@Belk.com. If any changes are due to merging, being sold, being acquired, going into Chapter 11, or going out of business, the changes must be communicated to Belk in writing on company letterhead and signed by a senior officer. The signed letter can be sent as a PDF to VendorRelations@Belk.com. The following information must be included in correspondence:

- Old parent company name and new parent company name
- Old company address and new company address
- Description of change (e.g., merger, etc.)
- Effective date of change

Note: Payments will be remitted to the address listed on invoices. Any invoices sent to Belk after the effective date of any changes must contain the new information.

Section Two: Vendor Terms and Conditions

2.1 Acceptable Business Practices

Belk values its relationships with vendors and business partners and would like to be clear on practices that could violate the Belk Code of Ethics. The following requirements and prohibitions are supplemental to those set forth in the Belk Private Brands Code of Conduct (as hereinafter defined).

Belk Gift Policy Belk associates may not accept anything of value, directly or indirectly, from anyone currently doing business with or seeking to do business with Belk, other than non-cash gifts of nominal value generally used for promotional purposes. For purposes of this gifts policy "nominal value" means not more than \$50 in value at cost. Gifts received of greater than nominal value will be returned immediately to the donor or donated to a charity. Belk associates may not accept gifts of cash or cash equivalent such as gift cards for any reason.

Loans Belk associates may not accept loans from any persons or entities having or seeking business with Belk except from recognized financial institutions at their normal prevailing interest rates for individual borrowers at the time of borrowing.



Bribes and Kickbacks Any offers or exchange of direct or indirect payments, or kickbacks in exchange for Belk business is a violation of policy and prohibited. The violation of this policy may also be a criminal act and result in criminal prosecution.

Fair Competition Belk bases its business success on excellent customer service, value for the customer, quality, good faith, and fair dealing. It is never Belk's intent to receive an advantage over competitors in any unethical manner or in ways that would violate international, federal, state, or local laws.

Reporting Fraud or Unethical or Illegal Business Practices Please report any suspected fraud or unethical or illegal business practices, including questionable accounting or improper use of confidential information or property to the Belk Excel Line (1-800-622-3986). The Excel line is monitored by an independent third-party service operating 24 hours, 7 days a week. These concerns may be reported anonymously, will be treated confidentially, and will be reviewed by Belk Management. These policies help ensure relationships of integrity, honesty, and fairness with all vendors and business partners.

2.2 Code of Conduct

Every vendor must sign and return the Belk Private Brands Code of Conduct. Failure to comply with this requirement will cause the vendor to be ineligible for Belk production. It is important that Belk Private Brands vendors place business on behalf of its consumers and stockholders with suppliers and supply chain partners (collectively, "Suppliers") whose practices are compatible with Belk's brand values. Therefore, in accordance with these values the Belk Private Brands Code of Conduct (the "Code of Conduct") aims to achieve compliance with certain social, legal, human rights and environmental standards. By acceptance of the Code of Conduct companies are, within their scope of influence, committed to acknowledge the social, legal, human rights and environmental standards laid down in this Code and take appropriate measures within their company policy for their implementation and compliance by their Suppliers. Belk Private Brands vendors must, in addition, cause their Suppliers to ensure that the Code of Conduct is also observed within their own supply chains involved in production processes carried out on behalf of Belk.

This Code of Conduct outlines the basic requirements that all Belk Private Brand Vendors must meet in order to do business or continue to do business with Belk.

2.2.1 Human Rights

Legal Compliance

Suppliers must comply with all applicable local laws and regulations, industry highest standards, and any other relevant statutory requirements whichever requirements are more stringent. This not only includes compliance with the Code of Conduct but also compliance with the terms and conditions of purchase orders issued by or on behalf of Belk Private Brands.

Freedom of Association and Collective Bargaining

Suppliers must respect the rights of employees to lawfully and peacefully join organizations and associations or not to associate with groups of their choosing and bargain collectively as long as such groups and activities are legal in the country where merchandise is manufactured. Workers shall not be subject to intimidation or harassment in the peaceful exercise of their legal right to join or refrain from joining an organization.



Prohibition of Discrimination

Suppliers shall not discriminate against workers on the basis of race, religion, beliefs, gender, marital or maternal status, age, political affiliation or opinions, national origin, disability, sexual orientation or other basis not directly impacting a worker's individual skills and ability to perform the job. No discrimination shall be tolerated in hiring, remuneration, access to training, promotion, termination or retirement.

Compensation

Suppliers shall pay wages for regular working hours and overtime hours shall meet or exceed legal minimums and/or industry standards. Deductions from wages as a disciplinary measure are illegal, unless this is permitted by national law and a freely negotiated collective bargaining agreement is in force.

Working Hours, Wages & Benefits

Suppliers shall conform with applicable national laws and industry standards for working hours, compensation, benefits and overtime compensation.

Workplace and Worker Health and Safety

Suppliers shall ensure compliance with applicable laws and regulations relating to health and safety issues including classification, workplace risk analysis, reporting and inspections by authorities. The company shall provide a safe and healthy workplace environment and shall take effective steps to prevent potential accidents and injury to workers' health arising out of, associated with, or occurring during work, by minimizing, so far as is reasonably practicable, the causes of hazards inherent in the workplace environment, and bearing in mind the prevailing knowledge of the industry and of any specific hazards. The required corrective actions from such inspections shall be documented and completed within the set timeframe.

A clear set of regulations and procedures must be established and followed regarding occupational health and safety, especially the provision and use of personal protective equipment, access to clean toilet facilities, access to potable water and if appropriate, sanitary facilities for food storage shall be provided. The company shall ensure that any dormitory facilities provided for personnel are clean, safe, and meet the basic needs of the personnel. All personnel shall have the right to remove themselves for imminent serious dangers without seeking permission from the company.

Prohibition of Child Labor

Belk does not accept child labor. Suppliers must abide by the United Nations Convention of the Rights of the Child (1989) and comply with all relevant national and international laws, regulations and provisions applicable in the country of production or operation. Workers can be no less than 15 years and not younger than the compulsory age to be in school. We will not utilize partners who use child labor in any of their facilities. The use of legitimate workplace apprenticeship programs, which comply with all laws and regulations, is supported. Workers under the age of 18 shall not perform work that is likely to jeopardize the health or safety of young workers. In the event that children are found to be working in situations which fit the definition of child labor above, policies and written procedures for remediation of the children found to be working shall be established, documented and executed within 45 days by the supplier company.

Prohibition of Forced and Compulsory Labor

The Supplier shall not make use of any of the forms of forced labor or labor utilizing slavery or human trafficking, exploited labor, prison labor, bonded labor, indentured labor, or involuntary labor, including any labor provided under duress. Neither Supplier nor any entity supplying manufactured goods, or labor to Supplier shall withhold any part of any personnel's salary, benefits, property, or documents in order to force such workers to continue working for Supplier. Personnel shall have the right to voluntarily leave the workplace premises and be free to terminate their employment without penalty. Neither Supplier nor any entity supplying manufactured goods or labor to Supplier shall engage in or support trafficking in human beings. Suppliers shall abide by the California SB 657 Transparency in Supply Chains Act of 2010 and comply with all relevant national and international laws, regulations, and provisions applicable in the country of production or operation. Supplier shall treat all personnel with dignity and respect. Supplier shall not engage in or tolerate the use of corporal punishment, mental or physical coercion, requiring workers to surrender original identification documentation as a condition of employment, or imposing a fee or financial obligation as a condition of employment.

Management Systems

Suppliers shall define and implement a policy for social and human rights accountability and the appropriate management systems shall be in place to ensure that the Code of Conduct can be followed and is being followed. All Supplier employees shall have access to this Code of Conduct. Management is responsible for the correct implementation and continuous improvement by taking corrective measure and periodical review of the Code of Conduct to all employees. It shall also address employees' concerns of non-compliance with this Code of Conduct.

Prohibition of Conflict Minerals Usage

Suppliers shall not make use of any forms of gold, tin, tantalum or tungsten mined in the Democratic Republic of Congo (DRC) or its neighboring countries. Suppliers shall abide by Section 1502 of the Dodd-Frank Act required by the Securities and Exchange Commission (SEC), with best practices of having conflict mineral policies, due diligence frameworks and management systems consistent with the Organization for Economic Cooperation and Development (OECD) guidelines. Belk may request of its suppliers written evidence of this due diligence documentation, including formal certifications and policies.

2.2.2 Sustainability

Environmental Project Management

Suppliers must comply with all applicable local, U.S. and international laws, rules, regulations and standards including U.S. regulations prohibiting the use of ozone depleting chemicals (hydrochlorofluorocarbons) and the International Trade in Endangered Species of Wild Fauna and Flora, as listed in the United States Endangered Species Act of 1973, as well as any modifications or amendments to these laws, rule regulations and standards.

Environment – Air, Noise, Water and Ground

Suppliers must meet or exceed minimum compliance with applicable laws and regulations relating to environmental protection for air, noise and ground, and if required, obtain the necessary permits and test.

Chemicals, Hazardous and Non-Hazardous Waste

Suppliers shall ensure compliance with applicable laws and classification regulations relating to purchasing, storing, handling, use and transportation of chemicals and hazardous and non-hazardous waste. The requirements are applicable for all chemicals used in production, operations and maintenance. Suppliers shall have documented procedures for the purchasing, storage, handling and use of chemicals. Suppliers shall have valid permits for all chemicals that are legally restricted or controlled and shall demonstrate compliance with these permits. The Belk supplier shall establish and maintain an updated list of all chemicals, including the name of the chemical product, the purpose/area of use and a reference to an MSDS (Material Safety Data Sheets) used in production, operations and maintenance.

The workers that purchase, store or handle and use chemicals must have the right competence and adequate training before starting work. Records of the training shall be kept by the Belk supplier including the names of participants, date of the training and an overview of the training content. Chemicals shall be stored, handled and transported in a way that prevents emissions to air, ground and water, prevent risks of ignition/explosion and ensure workers health and safety. Applicable information regarding the risks and safe handling of chemical compounds and substances shall be displayed at storage areas and in operations areas where the chemical is used. All containers of chemicals, including temporary containers, shall be properly labeled with appropriate danger symbols and chemical names to ensure that the contents are known, and the potential risk minimized.

Fire Prevention

Suppliers shall ensure compliance with applicable laws and regulations relating to fire protection including fire classification, reporting, and inspections by the fire authorities. Corrective actions from such inspections shall be documented and completed within set timeframes. Suppliers must document any fires and serious incidents that can cause a fire, including corrective and preventive actions. If required by law, a report shall be sent to the authorities.

An adequate number of workers must be trained to use the firefighting equipment in each work area, covering all shifts. Records of the training shall be kept by the Supplier including names of participants, dates of the training and an overview of the training content. All workers shall be made aware of basic safety issues before starting work through introductory training. Suppliers shall have the appropriate firefighting equipment. Placement and maximum distance between fire extinguishers shall comply with applicable laws and regulations and/or specific approvals from the fire authorities. The firefighting equipment shall be easily accessible and identifiable, also from a distance. It shall be maintained, kept unlocked and inspected at least every 12 months. Emergency exits and routes shall ensure a fast and safe evacuation of all workers. Suppliers shall, as a minimum, have two independent emergency exits per working area and ensure all emergency exits and access routes are free from obstruction. All emergency exits and routes shall be marked with luminescent or illuminated signs and shall be visible from the main aisles. There must be an independent and functioning evacuation alarm with continuous sound to notify all workers about an emergency situation and to ensure a fast and safe evacuation of the facility(s). The alarm shall be able to be manually activated and shall after activation evoke a continuous signal by itself. The alarm button shall be clearly marked and function also during power-outages. Supplier shall perform evacuation drills at least once in every 12 months. These drills shall involve all shifts and departments and as many workers as possible. In case of an

evacuation, the Belk supplier shall ensure that designated persons are responsible for performing a head count to ensure all workers have evacuated the building. Records of evacuation drills shall be maintained.

2.2.3 Terms of Implementation

All Private Brands Domestic Importers shall cause their Suppliers to post the Code of Conduct in places in their factories readily accessible to workers, translated into the language of the workers and supervisors and communicate these provisions to all workers. All Private Brands Domestic Importers and their Suppliers shall take appropriate steps to ensure the provisions of this Code of Conduct are communicated to all workers. Upon employment, as part of worker orientation, the Code of Conduct shall be presented to workers and explained to them. From time to time all Private Brands Domestic Importers and their suppliers shall periodically review the Code of Conduct with workers.

All Suppliers are obliged to take the measures necessary to implement the Code of Conduct.

2.2.4 Consequences of Non-Compliance

Suppliers must apply these principles at all times and must be able to demonstrate that they are doing so. However, if a supplier fails to meet the requirements of the Code of Conduct Belk and/or our representatives will work with the supplier to establish the necessary improvements. We will also take action which may involve cancelling contracts and ceasing trade, if suppliers are not prepared to make appropriate changes. If no solutions can be agreed upon and implemented within a reasonable amount of time, Belk and/or our representatives may choose to halt current production, cancel corresponding contracts, suspend future contracts and/or terminate the business relationship with the noncompliant supplier. If an audit reveals less than full compliance with the Code of Conduct, the supplier must take the prescribed corrective actions without delay. The period of time the supplier has to implement corrective measures will be agreed upon with Belk and/or our representatives and will correspond to the severity of the violation but may not exceed twelve months. If a supplier excluded in the past on grounds of noncompliance can later show full compliance with the Code of Conduct, there is, in principle no reason why a business relationship cannot be resumed.

2.2.5 Restricted Countries of Production

No orders may be placed with product manufactured in the below listed countries without explicit written approval from Belk’s Global Trade and Customs Compliance (GTCC). Please contact GTCC@belk.com if you have current production or future plans to produce in one of the below restricted country of origins.

AFGHANISTAN	CHINA	KOREA, NORTH	SENEGAL
ALGERIA	COMOROS	KYRGYZ REPUBLIC	SEYCHELLES
ARMENIA	CONGO, DEMOCRATIC REPUBLIC OF THE	LESOTHO	SOMALIA
ARUBA	CUBA	LIBYA	SOUTH SUDAN
AZERBAIJAN	Curaçao	MACAU	SRI LANKA



BANGLADESH	DOMINICAN REPUBLIC	MALAYSIA	SUDAN
BARBADOS	EQUATORIAL GUINEA	MALDIVES	SYERIA
BELARUS	ERITREA	MALI	TANZANIA
BELIZE	FIJI	MARSHALL ISLANDS	TIMOR-LESTE
BHUTAN	THE GAMBIA	MAURITANIA	TURKMENISTAN
BOSNIA AND HERZEGOVINA	GUINEA	NICARAGUA	UGANDA
BRUNEI	GUINEA- BISSAU	NIGERIA	UZBEKISTAN
BURMA (MYANMAR)	HONG KONG	PAKISTAN	VENEZUELA
BURUNDI	IRAN	PAPUA NEW GUINEA	VIETNAM
CAMBODIA	IRELAND	ROMANIA	YEMEN
CAMEROON	JORDAN	RUSSIA	ZAMBIA
CHAD	KAZAKHSTAN	SAUDI ARABIA	

2.2.6 Declaration

Declaration of Liability Regarding Compliance with the Belk Private Brands Code of Conduct
We, the undersigned hereby confirm:

That we have received and understand the Code of Conduct.

That we are aware of all relevant laws and regulations of the country or counties in which our company operates.

That we will inform Belk or the agent on behalf of Belk in case of conflict between provisions of the Code of Conduct and any applicable laws or regulations in our countries of operation.

That we will observe and conform to the Code of Conduct in its entirety based on a development-oriented approach and without amendment or abrogation.

That Belk agents and/or any third-party organization acting on Belk's behalf may carry out audits with or without notice at business premises of our contractors and subcontractors at any time. Furthermore:

We shall notify Belk or the agent on behalf of Belk of the location of all business premises used for the production of goods and/or delivery of services for Belk or the agent on behalf of Belk. We guarantee that the production of goods and/or delivery of services for Belk or the agent on behalf of Belk is carried out exclusively at the locations we have indicated. We understand that failure to inform Belk or the agent on behalf of Belk of the location where work for its products and/or services are carried out is adequate justification for the immediate and unconditional termination of all business and contractual relationships.



We will use the Code of Conduct for purposes relating to business and monitoring activities on behalf of Belk.

2.3 Confidentiality

Belk has developed certain confidential and proprietary information, including but not limited to, trademarks, patentable inventions, financial statements, financing documents, business plans, trade secrets, new products, copyrights, and computer software, documentation, and specifications. The vendor agrees not to disseminate Belk confidential information to anyone except its employees and consultants who are directly involved in this vendor/ retailer relationship. The vendor agrees to hold any employee or consultant to whom Belk confidential information is transmitted to be bound to the same obligations of secrecy and confidentiality that the vendor is bound.

2.4 Disposition of Merchandise

Disposition of Belk private label merchandise is prohibited without prior written approval from Belk. Failure to comply can subject vendors to liability for trademark infringement and for all losses and damages suffered by Belk and its affiliated entities as a result of such prohibited disposition. The required form can be requested from the Sourcing Operations VP. All forms must be signed and returned and on copy with Belk's legal department.

2.5 California Proposition 65

California's Proposition 65 (also known as the Safe Drinking Water and Toxic Enforcement Act of 1986) requires most businesses to give a "clear and reasonable warning" to individuals in the state before knowingly and intentionally exposing those individuals to significant levels of a chemical on the state's list of known carcinogens and reproductive toxins. There are currently over 900 chemicals listed under Proposition 65.

Belk's requirements for Proposition 65 warnings following recent revisions to the warning regulations, which will take effect on August 30, 2018. More information is available at <http://oehha.ca.gov/proposition-65/crnrr/notice-adoption-article-6-clear-and-reasonable-warnings>.

Key changes include:

- Warnings must now identify at least one chemical in the product associated with the toxicological endpoint (cancer or reproductive harm) for which the warning is being given. Truncated warnings without reference to the chemicals may be used on product labeling and may be provided online only if the product is labeled with such warnings.
- Warnings must include a warning symbol () and link to OEHHA's Proposition 65 information page: www.P65Warnings.ca.gov.
- Specific warning methods and messages are required for certain product types, including furniture.

If Belk is selling online any of a Supplier's products that require or are labeled with a Proposition 65 warning, Supplier must provide Belk with the warning language to be used for such online sales. Inspection, approval, or assistance by Belk of the Supplier warning does not relieve Supplier's obligation to comply with Proposition 65 and your duty to defend, indemnify, and hold harmless Belk if the compliance of the Supplier's products is challenged.

Population of the Prop 65 Attribute must be done in OpenText Catalogue. There are two Prop 65 attributes, the existing Yes/No attribute (Proposition 65 Warning, Y/N) and the new text field description attribute (Proposition 65 Warning Description). For new GTINs, if the Y/N attribute is set to Y, Catalogue will require the description attribute to be set. Existing GTINs with the Y/N attribute already set will require the description attribute if they are edited in any way.

Please direct any inquiries and any warning labels with respect to Proposition 65 to Product_Integrity@belk.com.

2.6 Vendor Compliance

- Merchandise, including its advertising, labeling, branding, packaging, manufacture, delivery and sale, conforms to all applicable state, federal, and local laws and regulations, and may lawfully be sold in all jurisdictions in which Belk operates its stores.
- If applicable to the merchandise, vendor will: (i) comply with all certification, testing, and other product safety requirements, including furnishing any General Conformity Certificate or Certificate of Conformity (“Certificate”) required by the Consumer Product Safety Act of 2008 and complying with any reasonable audit request from Belk; and (ii) maintain a continuing guaranty with the Federal Trade Commission or the Consumer Products Safety Commission, as applicable, in such form as may be required from time to time by applicable rules and regulations. Vendor hereby represents that it will furnish or provide such Certificates to Vendor as to all merchandise (and will comply with any reasonable audit of Belk) upon receipt.
- Vendor represents that it complies and shall remain in full compliance with the Foreign Corrupt Practices Act and all similar anti-corruption laws in any and all relevant jurisdictions, which generally prohibit giving money or anything of value to foreign government officials, foreign political parties, or foreign political candidates for the purpose of influencing a foreign government. This includes giving improper payments to intermediaries of such individuals, such as sales representatives. Vendor further represents that it complies with all applicable federal, state, local and international laws relating to the manufacture and production of products sold to Belk, including compliance with all applicable laws relating to labor compensation, working conditions, child, slave, prison or forced labor, environmental protection, product safety, and similar obligations.
- Vendor represents that it complies with all U.S. export controls and trade sanctions, that it is not subject to any sanctions administered by the Office of Foreign Assets Control of the U.S. Treasury Department (“OFAC”), and that it will not directly or indirectly use the proceeds of sales to Belk, or lend, contribute or otherwise make available such proceeds, to any subsidiary, joint venture partner or other person or entity, for the purpose of financing the activities of any person or entity subject to any sanctions administered by OFAC.
- No product-specific state, federal, or local laws and regulations apply to the sale of the merchandise at the retail level, including but not limited to: purchaser age limits; point of sale or other warnings, labels, or signs; assessment fees on retail pesticide sales, special disposal procedures, or retailer licensing/permitting requirements.
- Vendor shall guarantee that all merchandise ordered has been priced, stamped, labeled, tagged, marked, invoiced, and delivered in full compliance with (i) all applicable international, federal, state, and local government (and all departments, boards, bureaus and commissions thereof)

laws, rules, standards, orders, rulings, rules, guides and regulations, including, but not limited to the Federal Trade Commission Act, the Consumer Product Safety Act, the Transportation Recall Enhancement, Accountability, and Documentation Act, the Textile Fiber Products Identification Act and regulations relating to statement of fiber content of rayon, wool, linens, and other textiles contained in such merchandise, the Wool Products Labeling Act, the Care Labeling Rule, the Fair Packaging and Labeling Act, the Magnusson-Moss Warranty Act, the Federal Hazardous Substances Act, the Poison Prevention Packaging Act, the Radiation Control for Health and Safety Act, the Food, Drug and Cosmetics Act, California Proposition 65, and the Fur Products Labeling Act, and (ii) the laws, regulations and rules of all countries in which merchandise is produced or delivered. Vendor shall provide to Belk any information that is required to be displayed in order to comply with laws applicable to eCommerce sales of the merchandise [including but not limited to any California Proposition 65 warnings].

- Guarantee that all merchandise ordered has been or will be manufactured, compounded, or produced in full compliance with (i) all applicable federal, state, and local government laws, rules, and regulations, specifically including, without limitation, all applicable minimum wage, overtime, and child labor laws, rules, and regulations and (ii) the Belk Private Brands Code of Conduct.
- Merchandise has not been subject to any voluntary or involuntary recall or other corrective action by any government agency or regulatory body. Vendor shall promptly inform Belk of any recall or other corrective action undertaken after the merchandise is delivered to Belk, as far in advance of such corrective action as practicable, but in no case less than 5 days before any press release or other public announcement.
- If an order is cancelled or returned for any reason, all Belk price stickers and/or hangtags must be immediately removed from the merchandise. Should the merchandise be resold by vendor, it must bear no Belk markings, tags or identification.
- The merchandise is manufactured in the country of origin stated on the commercial documents required for United States Customs entry. In the event Belk reasonably believes the merchandise to be in violation of transshipment regulations, Belk may cancel any order, in whole or in part, and return the merchandise to vendor, for a full refund of the purchase price (including all handling, transportation, shipping, and other costs incurred by Belk in connection therewith).
- Warrant to Belk and its customers that merchandise is free from defects of workmanship and material and is fit for normal use by the consumer.
- Defend, indemnify, and hold Belk harmless from and against all claims, damages, losses, liabilities and expense (including reasonable attorneys' fees) which arises out of, results from or is based on:
 - Any actual or alleged defect in the merchandise ordered.
 - Any actual or alleged patent, copyright, trade secret, or trademark or other intellectual property infringement arising from vendor's manufacturer, sale, or export, or purchaser's use, sale or offering for sale of any merchandise ordered.
 - Belk and customers' reliance upon the warranties set out in above bullets.
 - Any gross negligence, willful misconduct, fraud, or violation of law by vendor or any of its Suppliers.
 - Any unfair competition.



- Any unfair or deceptive trade practices in connection with the merchandise and/or the product content furnished by vendor to Belk.
- Personal injuries or other damages sustained by any person from the use or misuse of the merchandise.
- Any claim of strict liability, negligence, recklessness or willful misconduct on the part of vendor and/or relating to the merchandise.

2.7 Insurance

- Supplier shall, at its own expense, secure and continuously maintain, and shall require its subcontractors to secure and continuously maintain, the following insurance with companies rating A-VII or better in the current Best's Insurance Reports published by A. M. Best Company and shall, within thirty (30) calendar days furnish to Belk certificates and required endorsements evidencing such insurance. Belk shall be named as an "Additional Insured" to the coverages described below for the purpose of protecting Belk from any expense and/or liability arising out of, alleged to arise out of, related to, or connected with the merchandise or services provided by Supplier and/or its subcontractors. The certificates shall state the amount of all deductibles and self-insured retentions and shall contain evidence that the policy or policies shall not be canceled or materially altered without at least thirty (30) calendar days' prior written notice to Belk. A Notice of Cancellation will be issued by Supplier's insurance carrier in the event of cancellation for any reason. Supplier and its subcontractors shall pay any and all costs which are incurred by Belk as a result of any such deductibles or self-insured retentions to the extent that Belk is named as an "Additional Insured," and to the same extent as if the policies contained no deductibles or self-insured retention. The insurance coverages and limits required to be maintained by Supplier and its subcontractors shall be primary and non-contributory to insurance coverage, if any, maintained by Belk. Supplier and its subcontractors and their underwriters shall waive subrogation against Belk and shall cause their insurer(s) to waive subrogation against Belk.
- Insurance Coverage:
 - Workers' Compensation Insurance (where required by law) which shall fully comply with the statutory requirements of all applicable laws.
 - Commercial General Liability Insurance, including Product Liability coverage, with a minimum combined single limit of liability of \$1,000,000.00 per occurrence and \$2,000,000.00 annual aggregate and excess liability on a follow form basis with \$3,000,000 per occurrence and annual aggregate, for any negligent acts committed by vendor and/or its employees, subcontractors or agents during the production of the merchandise or delivery of the services or any work hereunder. Such limits may be satisfied with a combination or primary and excess liability policies.
 - An additional \$5,000,000 per occurrence and annual aggregate excess liability insurance on a follow form basis is required for any vendor providing merchandise specifically marketed to children under the age of fourteen (14), including clothing, shoes, toys and other related items.
- The failure of Belk to obtain certificates, endorsements, or other forms of insurance evidence from Supplier and its subcontractors is not a waiver by Belk of any requirements for the Supplier and its subcontractors to secure and continuously maintain the specified coverages. Supplier

shall send its certificates, endorsements, or other forms of insurance evidence from Supplier and its subcontractors to the following email address: BelkRiskDept@belk.com. Supplier shall notify and shall advise its subcontractors to notify insurers of the coverages required hereunder. Belk's acceptance of certificates and/or endorsements that in any respect do not comply with the requirements of this Section does not release the Supplier and its subcontractors from compliance herewith. Should Supplier and/or its Subcontractors fail to secure and continuously maintain the insurance coverage required herein, Supplier shall itself be responsible to Belk for all the benefits and protections that would have been provided by such coverage, including without limitation, the defense and indemnification protections.

Section Three: Purchase Orders

3.1 Purchase Order Types

Bulk Order: You may receive a purchase order with the location designation of 850. This order is a bulk purchase order and will reflect the total quantity Belk plans to order. A new purchase order with a quantity by store allocation will be transmitted closer to the ship date. 850 is not a store to ship to.

Store Allocated Order: The Store allocated purchase order will provide a list of the specific SKUs and quantities that are to be shipped for each store. The store allocated order will be sent to the vendor in advance of the ship date according to the agreed upon lead-time with the Buyer.

eCommerce Order: eCommerce orders will typically be transmitted to vendors separately from all other store orders and will carry the designation of store 888. All orders for store 888 are to be shipped following the eCommerce product preparation requirements in section 6.6 of this guide.

3.2 Purchase Order Requirements and Restrictions

Below are the requirements and restrictions on all Belk purchase orders:

- Do not ship merchandise before the not before ship date listed on the purchase order.
- Do not ship merchandise after the not after /cancel date listed on the purchase order.
- Ship only one time per purchase order, and ship the order complete. There should be only one shipment per purchase order to each of the Belk destination distribution centers.
- Do not ship excess quantity that is not on the purchase order.
- Do not ship items that were not ordered.
- Do not ship to a store that is not on the purchase order.
- Do not ship any SKU substitutions.
- Do not ship without a valid purchase order.
- Verify the accuracy of all purchase order details including purchase cost, retail price, and payment terms. Do not ship merchandise until all discrepancies on the purchase order have been corrected. Contact the Belk Buyer for all corrections.

3.3 Terms and Conditions of Purchase Orders

All Belk purchase orders are governed by the terms and conditions of that purchase order (the current version of which is set forth in Appendix A hereto) and the following (which may be amended by Belk from time to time):



- Belk reserves the right, at no risk or expense to Belk, to refuse or return any shipment or to have any designated carrier refuse or return a shipment that is not valid or authorized and/or does not conform to the not before date or not after / cancel date contained in the purchase order to which the shipment relates. This also includes any substitutions or merchandise shipped in excess of the purchase order quantity. Any shipment relating to a purchase order that has been canceled or not approved will also be subject to refusal.
- Belk assumes no risk or expense on any merchandise refused or returned for non-conformance with the terms and conditions of the purchase order.
- Belk must be notified in writing within 5 days of purchase order issuance if the purchase order is not accepted, including all terms and conditions as stated therein.
- Belk reserves the right, without penalty, to cancel any purchase order, in whole or in part, in the event that Belk's use of the merchandise is prevented, hindered, or delayed by or during the period of a force majeure event or circumstance outside of Belk's control, including without limitation any fire, flood, earthquake, epidemic, pandemic (including, but not limited to, COVID-19 and any voluntary or mandated mitigation measures with respect thereto), government action, riot, strike, war and/or other force majeure event.
- Belk will examine the merchandise included on the purchase order when received. If merchandise isn't what is on the purchase order, damaged, defective, of poor quality, or otherwise defective, Belk can return any or all of the product shipped.
- Vendor is responsible for including all applicable sales, use, or excise taxes in its purchase price. In the event a statutory exemption applies, Belk will be responsible for providing a valid exemption certificate to the vendor.
- Title to merchandise will not pass to Belk until merchandise has been received, inspected, and accepted as being in conformance with the terms of the purchase order.

BY ACCEPTANCE OF THE BELK PURCHASE ORDER, THE VENDOR AGREES TO THE FOLLOWING TERMS AND CONDITIONS OF PURCHASE ORDER (THE CURRENT VERSION OF WHICH IS SET FORTH IN APPENDIX A HERETO AND THE FOLLOWING WHICH MAY BE AMENDED BY BELK FROM TIME TO TIME):

- Deliver all merchandise in accordance with the purchase order at the prices stated in the purchase order.
- Guarantee that all merchandise ordered has been priced, stamped, labeled, tagged, marked, invoiced, and delivered in full compliance with (i) all applicable international, federal, state, and local government (and all departments, boards, bureaus and commissions thereof) laws, rules, standards, orders, rulings, rules, guides and regulations, including, but not limited to the Federal Trade Commission Act, the Consumer Product Safety Act, the Transportation Recall Enhancement, Accountability, and Documentation Act, the Textile Fiber Products Identification Act and regulations relating to statement of fiber content of rayon, wool, linens, and other textiles contained in such merchandise, the Wool Products Labeling Act, the Care Labeling Rule, the Fair Packaging and Labeling Act, the Magnusson-Moss Warranty Act, the Federal Hazardous Substances Act, the Poison Prevention Packaging Act, the Radiation Control for Health and Safety Act, the Food, Drug and Cosmetics Act, California Proposition 65, and the Fur Products Labeling Act, and (ii) the laws, regulations and rules of all countries in which merchandise is produced or delivered. Vendor shall provide to Belk any information that is required to be

displayed in order to comply with laws applicable to eCommerce sales of the merchandise [including but not limited to any California Proposition 65 warnings].

- Guarantee that all merchandise ordered has been or will be manufactured, compounded, or produced in full compliance with (i) all applicable federal, state, and local government laws, rules, and regulations, specifically including, without limitation, all applicable minimum wage, overtime, and child labor laws, rules, and regulations and (ii) the Belk Private Brands Code of Conduct.
- Belk reserves the right, without penalty, to cancel any purchase order, in whole or in part, in the event that Belk's use of the merchandise is prevented, hindered, or delayed by or during the period of a force majeure event or circumstance outside of Belk's control, including without limitation any fire, flood, earthquake, epidemic, pandemic (including, but not limited to, COVID-19 and any voluntary or mandated mitigation measures with respect thereto), government action, riot, strike, war and/or other force majeure event.
- Defend, indemnify, and hold Belk harmless from and against all claims, damages, losses, liabilities, and expense (including reasonable attorneys' fees) which arises out of, results from or is based on:
 - Any actual or alleged defect in the merchandise ordered.
 - Any actual or alleged patent, copyright, trade secret, or trademark or other intellectual property infringement arising from vendor's manufacturer, sale, or export, or purchaser's use, sale or offering for sale of any merchandise ordered.
 - Belk and customers' reliance upon the warranties set out in above bullets.
 - Any gross negligence, willful misconduct, fraud, or violation of law by vendor or any of its suppliers.
 - Any unfair competition.
 - Any unfair or deceptive trade practices in connection with the merchandise and/or the product content furnished by vendor to Belk.
 - Personal injuries or other damages sustained by any person from the use or misuse of the merchandise.
 - Any claim of strict liability, negligence, recklessness or willful misconduct on the part of vendor and/or relating to the merchandise.
- Belk reserves the right to take immediate credit for all goods that are to be returned to vendor because the goods do not meet the requirements of the purchase order.
- Belk reserves the right to dispose of vendor's goods at Belk's option if return authorization is not received by Belk from vendor within 30 days of original request.

Please review the current version of the full Terms and Conditions of Purchase Order in Appendix A. These conditions are transmitted with all Belk purchase orders and apply to all Belk purchase orders. Notwithstanding anything contained herein, Belk may amend such Terms and Conditions of Purchase Order from time to time.

Section Four: Product Information

4.1 UPC Item Set Up

All vendors must have valid UPC barcodes. To obtain UPC barcodes, vendors must have a GS1 company prefix. All UPCs must meet the following requirements:



- Assign UPC numbers at the stock keeping unit (SKU) level using National Retail Federation (NRF) standard color and size codes.
- Assign a unique UPC to each pre-pack configuration and make the pre-pack UPC available to Belk in the OpenText/GXS catalog. Use the standard NRF color and size codes for pre-pack UPCs.
- Size ranges cannot be changed once UPCs have been communicated to Belk. For example, "size 5" cannot be changed to "small". A new UPC must be provided. No pre-pack configuration changes will be accepted, a new UPC must be set up and provided to the Belk Buyer.
- Reuse of UPCs must be per GS1 standards of 30 months after the last shipment by the vendor. Compliance with proper code reuse is critical and strict adherence will be enforced.

4.2 GXS Items Set Up

Belk utilizes OpenText/GXS Active Catalog to transmit data via web service call. Belk is not working with any other catalog providers at this time. Vendors must provide the UPC catalog electronically via OpenText/GXS in advance of offering the product to Belk. Items and the UPC catalog must be set up with the following requirements:

- 12- or 13-digit UPCs
- Product ID and Product ID Description
- Standard NRF color and color description (Color descriptions in GXS must match color description on merchandise tickets)
- Standard NRF size and size description (Size must be the correct size for department in correct family of business-based or NRF standards)
- Country of Origin must be entered at time of set-up. Any changes to the country of origin must be maintained in GSX at all times.

4.3 Extended Attributes

Belk requires that extended attributes be provided via OpenText/GXS for all merchandise by category of business. All items should be set up in OpenText/GXS with appropriate attributes populated 8 weeks prior to ship date.

- Belk will utilize Global Standards (GS1) extended attributes and product attribute information in OpenText/GXS Catalogue must follow the Global Standards (GS1) 'Voluntary Guidelines for Exchanging Extended Attributes for Ecommerce'.
- For more information on extended attributes, please visit www.GXS.com/Belk and click on Belk Attribute Cross Reference.

4.4 Image Standards

Images must be provided to Belk a minimum of 8 weeks prior to ship date. All inquiries concerning Belk eCommerce specifications, including requests for image style guidelines can be directed to your Belk assigned Asset Procurement Coordinator.

- Images must be provided for every style/color number purchased by Belk.
- Images are to follow the GS1 standards available at http://www.gs1.org/sites/default/files/docs/gdsn/Product_Image_Specification.pdf.
- For product images, shoot against a white seamless sweep, card or tabletop; include slight shadows for visual grounding.



- For images on figure, shoot against or neutral colored seamless sweep; do not crop into model's head or face.
- Leave open space around subject for cropping discretion.
- Include front and back shots, additional alternative shots and lifestyle shots are preferred.
- Color: RGB.
- Post-Production: Add clipping path/silhouette to subject matter in Photoshop with a tolerance level of 0.
- File Size: Minimum 900 x 1200 pixels; either orientation.
- File Format: Hi-Res Tiff (.tiff), EPS, PSD, JPG, or JPEG file: 300dpi, 96dpi, 72dpi (if clipping path/silhouette added in Post-Production phase, save as layered .tiff file).

Vendor provided images are subject to Belk's approval and any possible acceptance or denial for use is solely at Belk's discretion. All inquiries concerning Belk's eCommerce image specifications, including requests for image style guides, can be directed to the Belk buyer.

4.5 eCommerce Sample Requirements

- A sample must be provided for every style/color purchased by Belk.
- Samples must be clearly marked with the style number and color code ordered for www.Belk.com.
- Samples must be provided in the appropriate size for the merchandise category.
- Samples should be sent to Attn: Belk Buyer/ Buyer number at the Belk corporate office.

4.6 Private Brands Color, Technical Design, and Quality Assurance

For additional information regarding required process and guidelines as it pertains to Samples, Color, Technical Design, and Quality Assurance, vendors should refer to the Belk Private Brands Vendor Business Requirements (VBR) SharePoint site for all additional documentation. These requirements are considered a part of the Belk VBR and are mandatory.

All sampling costs are at the vendor's expense.

All vendors are required to meet the product testing and final inspection protocols outlined in the VBR on the SharePoint site and all must be performed by an approved 3rd Party service provider, unless authorization has been granted by Belk for self- testing or self-inspection. All testing and inspection costs must be included in the cost of goods at the time of quoting. Beginning June 1st, 2022, all Apparel and Home vendors will be required to use Intertek for all product testing and final inspections. Intertek will become Belk's only nominated 3rd party provider. Please transition to using Intertek as quickly as possible.

The Belk QA team will be performing in-store Production Audits each season to review production quality of shipped goods. If any issues are found, Belk reserves the right to request mandatory 3rd party Final Inspections for a duration of 10 subsequent shipments or up to 3 months of shipments. In addition, depending on the severity and prevalence of issues found, Belk may issue additional quality chargebacks to cover product audit expenses, or as a % off of total shipped FOB value for styles found with issues, or may ask for a RTV of goods.

Issues will be communicated from the Sourcing Operations or Sourcing Team at the time of discovery.

If additional assistance is needed, contact the respective sourcing team or through the below specific inboxes.

Color@belk.com

Technical_Design@belk.com

[Quality Assurance and Product Integrity@Belk.com](mailto:Quality_Assurance_and_Product_Integrity@Belk.com)

Section Five: EDI Requirements

5.1 EDI Requirements

Belk requires Electronic Data Interchange (EDI) capabilities from all vendors. Please see below for the EDI documents and versions that Belk currently supports.

Belk can receive the following EDI documents:	Version:
810 Invoice	4030 VICS
832 UPC Catalog from GXS	4030 VICS
855 Reverse Purchase Order	4030 VICS
856 Advance Shipment Notification/Manifest	4030 VICS
997 Functional Acknowledgment	4030 VICS
Belk can send the following EDI documents:	Version:
820 Remittance Advice	4030 VICS
824 Application Advice	4030 VICS
850 Outbound Purchase Order	4030 VICS
852 Sales/Inventory Data	4030 VICS
860 Purchase Order Change	4030 VICS

5.2 EDI Terms and Conditions

By entering into a transaction with Belk through Electronic Data Interchange (EDI), the vendor agrees to the following terms and conditions:

- Vendor agrees to conduct merchandise transactions using the Voluntary Inter-industry Commerce Standards EDI protocol.
- Each party agrees that it will be responsible for its own costs associated with any EDI transmission, as well as any storage fees charged by a third-party service provider.
- Each party will be responsible for its own costs in developing and/or licensing its EDI software and for testing the efficiency of the software.
- If Belk provides sales and/or inventory data to vendor, Belk will use due diligence to ensure the accuracy; however, Belk makes no warranty as to such data being free of errors or omissions.
- Belk may assign its rights or obligations under this Contract to any affiliated entity.
- Vendor EDI documents must be created following the appropriate VICS EDI guidelines and the Belk mapping guide.

Please contact GS1 (www.GS1.org) for information on how to get started with EDI if you do not have EDI capabilities and plan to do business with Belk.

Section Six: Product Preparation

6.1 UPC Merchandise Ticketing Standards

All Private Brand Domestic Importers must use one of the three nominated suppliers for ticketing:
Avery Dennison, WFL RPAC



All merchandise, whether for stores or for eCommerce, must have a merchandise ticket attached to the product that includes the UPC barcode, human readable UPC, merchandise description, and the retail price. The UPC code must be visible and easily accessible for scanning.

- Merchandise tickets are to be printed on plain white pressure sensitive tickets and printed with non-smearable black ink. The ticket should be approximately 1.5" wide by 2.5" long.
- Stickers should be appropriately sized for the merchandise.
- The retail price, as stated on the Belk purchase order, must be placed in "zone 6" or "zone 7" of the standard UPC ticket using an 18-point, bold font. The Belk preferred format is \$79.00. Do not use 'MSRP' or 'suggested retail price' on the merchandise ticket.
- Follow the GS1 industry standard for merchandise ticket placement. The GS1 standard can be found at:
https://www.gs1us.org/DesktopModules/Bring2mind/DMX/Download.aspx?command=core_download&entryid=432&language=en-US&PortalId=0&TabId=134
- Attach UPC tickets so that the merchandise will not be damaged. UPC tickets should be securely attached to the merchandise by plastic swift-attach devices or by attachment to sewn on labels. If it is impractical to use either of these two methods of attachment for merchandise, tickets can be attached using a loop-lock attachment device (handbags), rat tail (sunglasses) or with an adhesive backed ticket (china, glassware, etc.). Do not loop strings around buttons or use strings attached with pins. When using an adhesive backed ticket, be sure that the ticket and adhesive can be easily removed from the merchandise and will not damage the merchandise.
- For garments with heat seals, the hang tag should be placed in the left shoulder seam.

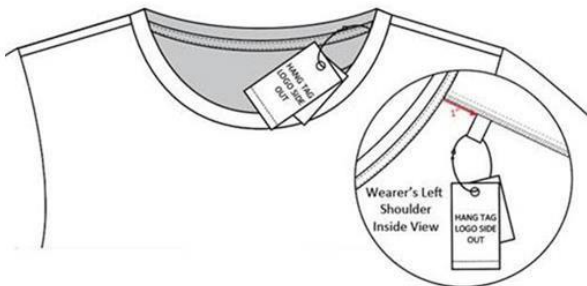

- For garments with heat seals that do not have a back neck or shoulder seam, the hang tag should be placed in the left side seam.

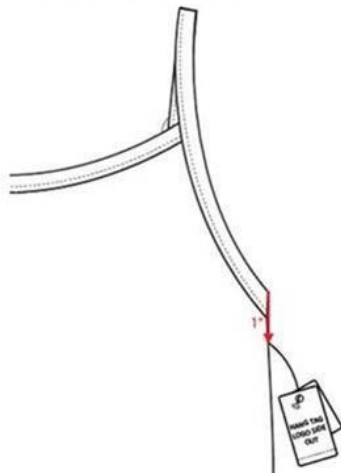

- For two-piece garments, mark the top garment with a full detail ticket (to include the UPC) and mark the bottom garment with a second ticket that includes the Product ID (PID) and size. Both tickets should state that this is a two-piece garment.
- For store orders, merchandise sold by the unit but packaged in multi-packs will require a UPC merchandise ticket to be attached to each individual selling unit as well as the outside of the carton. For example, glasses packed four to a carton but sold by the glass would require that a UPC price ticket be attached to each glass as well as having four UPCs attached to the outside of the carton.
- Fine Jewelry vendors should refer to section 6.7 for ticketing instructions for Fine Jewelry merchandise
- Below are **suggested formats** for merchandise tickets and stickers:



6.2 Hanger Requirements

Belk expects the vendor to ship merchandise on VICS approved standard floor ready hangers. For store orders, please confirm with Buyer if merchandise is to be shipped on a hanger or if it is to be shipped flat.

Belk follows all GS1 Hanger standards. Please reference the below link for more information.

https://www.gs1us.org/DesktopModules/Bring2mind/DMX/Download.aspx?command=core_download&entryid=383&language=en-US&PortalId=0&TabId=134

For all eCommerce / store 888 purchase orders, product should be shipped flat inside a polybag, unless it is listed as hanging in APPENDIX C ECOMMERCE FLAT AND HANGING GUIDE. Hangers must conform to the GS1 hanger standards by product category. With the exception of suits, all two-piece garments must use both a top and a bottom hanger connected by the coordinate loop. Belk hanger type, size, color requirements can be found listed in the APPENDIX D HANGER SPECIFICATIONS (including where sizers are required). For any hanger need outside of these set standards, vendor should get exception approval from Buyer. Please do not use foam padding (or loose fabric, etc.) inserts on pant hanger. Belk has chosen to nominate 2 hanger suppliers for private brand product. Supplier information and contact can be found below, please contact to set up an account and get access to the ordering system/order forms. Orders must go through nominated suppliers effective for goods that are shipping for Jan 2022 in store and later. Non-compliance of hanger type or vendor will result in chargebacks, detailed below:

Wrong hanger type - \$25 per receipt and \$0.60 per unit, minimum \$50.00 per receipt

Hanger sourced through non approved vendor - \$500 per order

Mainetti contact info: timothy.hourihan@mainetti.com *Country Contacts attached in Appendix H.

Sourcing Solutions Inc (SSI) contact info: sales@ss-intl.com

6.3 General Product Packaging Requirements

Close all buttons/zippers/hooks. Breakable products must be adequately packaged to prevent breakage during transit. Any merchandise received broken due to inadequate packaging will be deducted from the invoice.

Registered Identification Number

- Belk's RN # 31104 should be used on all Belk Private Brands products.

6.4 STORE ONLY Packaging Requirements

For all brick and mortar store orders (all orders for stores except store 888), please package product as follows:

- Group like product by style and color in one master polybag. Do not use individual polybags on single skus.
- Polybags need to have perforated tears for easy removal.
- If product is to be hanging, the garment must be shipped on the hanger. Do not bundle hangers with cable, twine, or rubber bands.
- Do not use pins, tape, clips, removable foam inserts on bottom hangers, excessive tissue or cardboard, or empty merchandise boxes as filler. There should be no excessive packing materials used.
- Alternate top and bottom placement in the carton to eliminate excess bulk, maximize cube, and prevent shifting.
- Folded merchandise must have a clear "size sticker" or "size strip" affixed to the merchandise. Stickers must use an adhesive that will not damage the merchandise.

6.5 ECOMMERCE ONLY Packing Requirements

Belk transmits eCommerce purchase orders with the designation of store 888. Store 888 orders will usually be transmitted as a standalone purchase order. All orders for eCommerce / store 888 must follow the eCommerce packaging and shipping requirements outlined below in 6.6.1 through 6.6.6.

6.5.1 eCommerce Individual Packaging

Merchandise must be individually packaged in a polybag or a box as an individual selling unit. All apparel merchandise should be flat folded in an individual polybag with no hangers. If the merchandise is a set, all pieces/components must fit into and be included in a single polybag. The polybag must contain all components for the complete selling unit. Please see Appendix E for any exceptions to this rule.

Boxed Merchandise (i.e. Home, Bakewear, Toys, Luggage, etc.) :

- Boxed merchandise does not need to be polybagged. However, the box must contain all components for the individual selling unit within one box. Gift wrapped/ boxed items (ex. candy) and boxes with openings (ex. slippers, toys, gadgets) must be placed in a polybag.



- Breakable merchandise such as cosmetics, fragrance, decorative home, tabletop, and electronics must be packaged to protect the merchandise when shipping to the consumer.
- All merchandise that is boxed in protective inner cartons (non retail-ready packaging) must have an UPC barcoded sticker affixed to the top of the inner carton.
- If item is sold in a set, please add “SOLD IN SET” sticker or marking near UCC-128 label. If
- merchandise is sold individually, please add “SOLD INDIVIDUALLY” sticker or marking near UCC- 128 label.

Non- Boxed Merchandise/ Apparel:

- All merchandise must be individually polybagged.
- No hangers are to be on apparel. Apparel is to be flat folded. (unless notated in Appendix XXXX)
- All polybags must have an UPC barcoded sticker affixed to the middle of the longest side of the polybag. See Section 6.6.6

EAS tags, including both hard and soft tags, should not be used on any eCommerce merchandise. Hard tags should not be applied to any eCommerce purchase orders. While the use of soft tags is not preferred, (either attached to packaging or sewn into product), if tags are applied to eCommerce merchandise, tags must be deactivated prior to shipment.

6.5.2 eCommerce Single SKU Cartons

- If an eCommerce purchase order calls for 6 or more units of a SKU, the merchandise must be shipped in a single SKU carton containing only this SKU. If a purchase order calls for 5 units or less of a SKU, the merchandise should be consolidated in a carton containing other SKUs with 5 units or less of the same SKU. Do not overbag like SKUs together in a mixed SKU carton.
- Due to the small size of cosmetic and jewelry products, these two categories of product may be exempt from this requirement when doing so will cause the carton to not meet the minimum
- eCommerce carton sizes listed in section 7.2. Please be sure that mixed SKU cartons are minimized wherever possible.

6.5.3 eCommerce Reshippable Packaging

- Individual product dimensions in the packaging must not exceed 26” L x 16” W maximum. If length and width are used interchangeably, items must still measure within this 26” and 16” specification. If the product cannot be folded in packaging to be less than these dimensions, then the product must be sent to Belk individually packaged in a reshippable carton. Reshippable cartons should meet the following requirements:
 - Use a rigid box with flaps intact
 - Remove any labels, hazardous materials indicators, and other previous shipment markings on the box that are no longer applicable
 - Use adequate cushioning material
 - Use strong tape designed for shipping
 - Do not use string or paper over-wrap

Please see Appendix F for more information on reshippable cartons.

6.5.4 eCommerce Category/Department specific eCommerce requirements:

DEPARTMENT	ECOMMERCE PACKING REQUIREMENTS	ECOM FLAT FOLD OR HANG
Cosmetics/Fragrances	Merchandise must not be shrink-wrapped, bundled or packaged together. MSDS for all cosmetic/fragrance must be sent to the Belk Fulfillment Center Attn: BFC Loss Prevention	NA
Fashion Accessories	Merchandise must be properly packaged to protect product and shape (ex. Handbags, Hats).	NA
Jewelry	Earrings must be attached to a card and posts must be protected to prevents damage during shipping. Watches must be shipped in the display case.	NA
Womens Special Occasion Dresses	Cocktail, formal, Bridal, Prom, delicate fabrics	Hang
Mens and Womens Dress Outerwear	Leather, Fur, Cashmere can be hung Active/Casual, Topcoats, Peacoats	Hang Flat Flod
Ladies Bras and Panties	Merchandise can be shipped on a small intimate hanger. Hangers must be tucked under the garment and sealed in a polybag. 2-piece items must always be packaged together as one selling unit within one polybag.	Flat Fold
Swimwear	Merchandise cannot be shipped on a hanger. 2-piece items must always be packaged together as one selling unit within one polybag.	Flat Fold
Mens	Suits, Suit Separates, and Suit Coats	Hang
Mens	All other apparel	Flat Fold
Men Furnishings	Belts must be coiled and individually packaged in a polybag. If coiling will damage the belt, please ship in an individual polybag and then coil the belt into a second polybag. Neckties must be folded and cardboard used to protect and maintain product shape inside the individual polybag.	Flat Fold
Kids	If sold as a set, all pieces must be included and fit in one polybag. Toys/plush must be shipped in individual polybags with a UPC barcoded sticker, unless packed in a sellable box with a UPC.	Flat Fold
Shoes	Shoe boxes must be strapped with rubber bands or plastic/paper strap to ensure tops and bottoms are secured; unless the shoe box has locking tabs that will keep the top lid securely closed. Shoes must be polybagged as a sellable unit if the shoe is not shipped in a closed sellable box. (Example: women's sandal) A polybag is not required if the shoe is shipped in a closed, sellable box with a UPC.	NA

<p>Soft Home: Towels/ Bath Rugs/ Tablecloths/Napkins</p>	<p>All merchandise must be individually polybagged with a UPC barcoded sticker on the outside of the polybag. If sold as a set, all pieces must be packaged together in one polybag. Rugs must not be shipped on a hanger; instead rugs must be flat folded or rolled in a polybag.</p>	<p>Flat Fold</p>
<p>Soft Home: Bedding</p>	<p>Additional packaging is not required for any merchandise shipped in fully enclosed retail-ready vendor packaging with a UPC (ex. Comforter set or sheet set in a vinyl bag). If a product is not fully protected by vendor packaging (ex. Banded fleece blanket), then the merchandise must be individually polybagged with a UPC barcoded sticker on the outside of the polybag. Comforters exceeding 26 (L) x 16 (W) inches must be shipped in a reshippable individual carton. Bed pillows need to be in a reshippable bag with barcoded sticker on the outside of the reshippable bag.</p>	<p>Flat Fold</p>
<p>Hard Home: Bath</p>	<p>Bath accessories must be shipped in a protective inner box with adequate packaging to prevent breakage.</p>	<p>NA</p>
<p>Cookware</p>	<p>Additional packaging is not required for any merchandise shipped in fully enclosed retail-ready vendor packaging with a UPC (ex. Boxed cookware set). If a protective inner box is used to protect merchandise, then the protective inner box must have a UPC barcoded sticker. Knives must be packaged for safety and shipped in a protective package or a box. No blades can be exposed. Merchandise must be individually packaged by sellable unit, with all set components shipped in one polybag or box. Merchandise cannot be group wrapped (ex. three pans shrink wrapped together) unless it is sold as one item.</p>	<p>NA</p>
<p>Hardgoods (China, Dec Home, Crystal, Glassware & Trim/Holiday Décor)</p>	<p>All merchandise must be shipped in protective packaging and must not require any additional repackaging to prevent breakage. Ornaments and Holiday décor must be packaged in individual protective boxes for each selling unit. The inner box must have a UPC sticker. All multi-piece items or sets must be packaged together in the same box and labeled with a UPC barcoded sticker (ex. butter dish and lid must be in the same box).</p>	<p>NA</p>
<p>Tabletop</p>	<p>All merchandise must be shipped in protective packaging and must not require any repackaging to prevent breakage. Components within sets must be packaged in a way to avoid breakage. Separators should be used to protect from breakage.</p>	<p>NA</p>

6.5.5 eCommerce Polybag Specifications

All eCommerce merchandise that is not packaged in a display box or container must be packaged in individual polybags containing the complete individual selling unit. Units sold as sets must be packed in the same polybag. Polybags must meet the following specifications:

- The polybag must be .9 mil to 1.5 mil in thickness and must be made of Polyethylene. Only clear plastic polybags may be used.
- Polybags thinner than 1 mil must contain the following caution statement printed on the polybag: "WARNING: TO AVOID DANGER OF SUFFOCATION KEEP AWAY FROM BABIES AND CHILDREN. DO NOT USE IN CRIBS, CARRIAGES, OR PLAYPENS. THIS BAG IS NOT A TOY".
- The polybag must be securely sealed either using a heat seal or tape to prevent merchandise from falling out of the bag.
- The polybag must not contain air holes, except for leather and suede items. These items should be covered with protection and shipped in polybags with air holes to allow the fabric to breathe.
- The polybag must fit the folded product with no more than 1" of excess space in the polybag on any side. For hanging product, the polybag should be sized to cover the entire garment and sealed on all sides. The polybag should be no longer than 6" below the garment.
- Recommended folding standards for apparel can be found in Appendix G.

6.5.6 eCommerce UPC Barcoded Sticker Requirements

The UPC Barcoded Sticker is required to have the following information:

- Item # = Vendor UPC number
- Color = Vendor color description
- Size /description abbreviation = Vendor Size / description
- Vendor UPC barcode: min. height of barcode is 9mm (.35") and must be scannable
- Sticker size: no smaller than 2" wide by 2" high
- Sticker printing: printed in non-smearable black ink on a white background
- Must be placed in the middle of the longest side of the polybag or in the middle of the longest scannable side of a box
- Please note that even if the UPC ticket/tag is visible through the polybag, a barcoded sticker must be on the outside of the polybag.

Ecommerce Polybag UPC Barcoded Sticker Example

P713266

COLOR: S399

MIDRISE WBB 5PKT SKINNY CUFFED

SIZE: **O**



Code Symbology	UPC-A 12	EAN 13
Number of characters	12	13
Narrow Bar/Space width	25mm (10mil)	.25mm (10mil)
Bar Height	9 mm (0.35")	9 mm (0.35")
Bar Code orientation	Omni	Omni
Location of bar code on product	Top, L-Side R-Side, Front, Rear	Top, L-Side R-Side, Front, Rear



6.6 Fine Jewelry Ticketing & Packing Requirements

Fine Jewelry departments are as follows: 537, 538, 539, 541, 542, 543, 544, 545, 546, 547, 548, 549, 550, 551, 552, 553, 554, 557, 558, 559.

- Vendors are to use Data 2 or the assigned Belk ticket supplier to provide Belk approved fine jewelry merchandise pricing tickets. Fine Jewelry merchandise tickets are to be blue in color. Please refer to the instructions sent from the buying team on where to place the merchandise tag on the product. The tag must be attached to the product.
- All Fine Jewelry orders should be shipped to the Belk Jonesville Fulfillment Center.
- Fine jewelry must be packaged to protect the product.
- Do not ship merchandise worth more than \$50,000 at cost to Belk in any single package / box. If your shipment is more than \$50,000 at cost, please split into multiple boxes as necessary so that no one box exceeds \$50,000.
- If a memo vendor has a signed contract between the vendor and Belk stating details other than those listed in this guide, the details of the contract between Belk and the vendor supersedes information listed in the Belk Private Brands Domestic Importer Vendor Business Requirements.

6.7 Gift with Purchase (GWP) Packing Requirements

- UPC codes must be assigned to all gift with purchase (GWP) and purchase with purchase (PWP) merchandise. These codes must be included in the vendor UPC catalog and on all EDI documents.
- All GWP / PWP merchandise must have a UPC ticket or sticker attached to the item.
- For eCommerce orders all GWP/ PWP merchandise must be in an individual polybag or box with a UPC barcoded sticker on the outside.

6.8 Lithium Battery Warning Label

All merchandise shipped to Belk with a lithium battery must have a warning label attached to the outside of the carton (see below). Without a warning label, vendor will incur chargeback.



6.9 Supplier Direct Fulfillment Packaging Requirements

Supplier Direct Fulfillment program orders should follow the SDF Vendor Participant policies available on the Belk website at www.Belk.com under Vendor Resources.

6.10 RFID

6.10.1 RFID Basic

Radio Frequency Identification (RFID) technology supports our OMNI operations to track and improve inventory accuracy. RFID is the wireless transfer of data to or from electronic tags that are attached to items of interest. RFID consists of 3 components namely, software, hardware and tags.

GS1 offers low-cost education and training on RFID enablement and its applications within retail. We urge you to reach out to GS1 to learn more about this technology if you are unfamiliar with RFID.

a) GS1 Standards:

<https://www.gs1.org/standards/epc-rfid/guidelines>

b) RFID training and education is also available on the GS1 US website at:

<https://www.gs1us.org/industries/apparel-general-merchandise/implementation-resources/epc-item-%20level-readiness-program>

RFID Basics

UPC/EAN to EPC

UPC/EAN Structure



EPC Structure

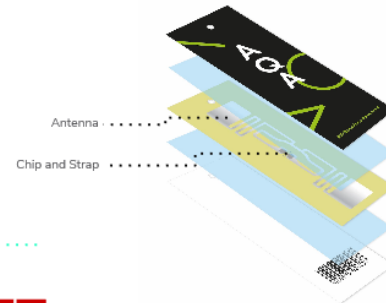

6.10.2 Belk Mandate

Effective June 2021, all Private Brand products are required to be shipped with a RFID hangtag or RFID sticker.

- Belk is mandating that RFID tags and stickers must be purchased from Avery Dennison for all Private Brand product.
 - Avery Dennison began accepting RFID Supplemental tag/sticker orders beginning December 18, 2020.
 - Avery Dennison began accepting RFID Integrated tag orders beginning September 1, 2021.
 - All pricing has been negotiated with Avery Dennison and there will be no further local discounting on these costs.
- RFID requirement applies to all Apparel, Soft Home products, Hard Home products, and all Handbags, Accessories and Fashion Jewelry.
- Product will EITHER use an integrated RFID hangtag / sticker OR will use a supplemental RFID hangtag / sticker.

- Please review **Appendix I** for a catalog of both supplemental and integrated RFID hangtag and sticker part numbers.
- Please contact Avery Dennison directly for negotiated pricing on each.
- Please use an Integrated RFID hangtag or sticker for all brands of apparel, home, and accessory products where available.
- All Footwear will use a large supplemental RFID sticker.
- If an integrated RFID / UPC tag or sticker is not available for your specific product or brand, please continue to use a supplemental RFID tag or sticker on your product.
- If you have any questions about which tag or sticker you should be using on your product, please reach out to Dina Samuel from the Belk marketing team with any questions dina_samuel@belk.com
- Cosmetics, Fragrances, and Fine Jewelry products are exempt from all RFID requirements.

6.10.3 Account Setup and Contact Info

Please contact **Avery Dennison to complete set up of an account**, as well as to schedule training on what to order, how to order, and how to apply the RFID hangtags / stickers.

- The Avery Dennison Service Bureau contacts are listed by County of Origin in Chart I below.
- RFID Integrated hangtags and stickers will be printed at Avery Dennison service locations in China, India, Vietnam, and Honduras.
- RFID Supplemental hangtags and stickers will be printed at Avery Dennison service locations in China, India, Vietnam, Honduras, and Mexico.
- Please reach out to Nancy Nelson at Avery Denison to complete account set-up as soon as possible
- Nancy.Nelson@averydennison.com; You must register an account with Avery Dennison to order tags / stickers.

6.10.4 Hangtags/Stickers and Lead Times

Avery Dennison has committed to shipping all Integrated tag and sticker orders within the following leadtimes:

- Integrated tags / stickers: 10 working days of order / payment receipt in China and Vietnam, and temporarily within 18 working days of order / payment receipt in India
- Supplemental tag / stickers: will be shipped within 10 working days of order / receipt payment.
- It is the Vendor's responsibility to plan RFID tag order timing to meet production needs, using the delivery commitments that Avery Dennison has made.
- Avery Dennison is working to reduce the India leadtime to 10 days as quickly as possible and expect to achieve this in Q1 2022.
- Note that there will be no MOQ per order.
- All order terms are ex works-EXW production locations. Products produced in China and shipped to the USA will be subject to a 25% tariff added to invoice.

- All Integrated items will be available in the following countries for orders / exports: China, Vietnam, and India.
 - Vendors will have the ability to order from Honduras, however the Vendor will need to reach out to Avery Dennison immediately to discuss specific needs by tag type; With a forecast, Avery Dennison will be able to fulfil tag / sticker orders in Honduras within 10 days.
 - If you are interested in Honduras or USA options, please reach out to Fabian Blanco from Avery Dennison at Fabian.Blanco@averydennison.com

Chart I

Service Bureau	Vendor Bill To Region	Primary Contact Name	Primary Contact E-mail	Primary Contact Phone	Secondary Contact Name	Secondary Contact E-mail	Secondary Contact Phone
China (Nansha)	TAIWAN	Gemma Chen	gemma.chen@ap.averydennison.com	8620-3233 5144	Lena Li	lena.li@ap.averydennison.com	+86 203 2032335141
	CHINA :W Z						
	BANGLADESH	Fiona Chen	fiona.chen@ap.averydennison.com	8620-3233 5162			
	INDIA						
	VIET NAM						
	INDONESIA						
	CHINA :O-T						
	UNITED STATES	Joanna Zhou	joanna.zhou@ap.averydennison.com	8620-3930 6861			
	CANADA						
	KOREA	Lauren Chen	lauren.chen@ap.averydennison.com	8620-3233 5142			
	JORDAN						
	EGYPT						
	GUA TEMALA						
	HONG KONG						
	PAKISTAN						
SINGAPORE							
SRI LANKA							
TURKEY							
CHINA:UV X Y							
CHINA:A-N	Rita Huang1	rita.huang1@ap.averydennison.com	8620-3233 5159				
ICE/IPPS							
Honduras	Mariana Pardo	mariana.pardo@averydennison.com	(+52) 442-229-5600 ext 652	Veronica Brenis	veronica.brenis@averydennison.com	+ 52 442 2265600 ext 628	
India	Harinakshi	harinakshi.c@ap.averydennison.com	+ 91 7022029199	Ramya Raju	ramya.raju@ap.averydennison.com	+ 91 7022029209	
Vietnam	Truc Nguyen	Mnhtruc.Nguyen@ap.averydennison.com	Tel: +84 2837763181 (direct) HP: +84 908 950 915	Doan Nguyen	cassie.nguyen@ap.averydennison.com	Tel: +84 8 3776 3336 (Ext: 3719) HP: +84 32 945 2715	

RFID Placement Guidelines:

- RFID hangtags/stickers are to be applied based on these guidelines. RFID should NOT cover barcode, price and description fields such as style, color, size.
- RFID must adhere properly to the products, if there is any issue with adhesion of the stickers to the products, vendor must contact Avery Dennison to work out a solution.
- Metal products may interfere with the RFID signal. Do not place a RFID sticker directly on a metal surface. Metal products should use a RFID hangtag, or a sticker placed on a non-metal surface, like a bellyband or cardboard. If you have questions about whether your product is compatible with RFID hangtags or stickers, please reach out to Fabian Blanco at Avery Dennison fabian.blanco@averydennison.com. Products that are confirmed to be non-compatible with RFID will be exempt from RFID requirements.

In addition, Belk requires the following placement guidelines by category:

Hanging Apparel:

- Always default to Hangtag if a hangtag is used on the product for the Retail / UPC information.



- Stickers are approved for items without hangtags.
- Do not apply stickers directly to fabric, must be applied to an existing label or joker tag.
- Avoid covering any important information.

Packaged Apparel:

- Stickers are approved for packaged apparel, based on size of package use either small or large sticker.
- Apply on back and nearest the top of the box/package.

Footwear:

- Always default to a large sticker.
- Apply to the side of box next to the size, color, and style identification.
- Avoid covering of any important information.

Accessories:

- Use an integrated or supplemental hangtag if product carries a Brand or Retail / UPC hangtag.
- Approved for both small and large sticker on backer cards, however preference is to use large sticker if space allows.
- Apply to backer card or packaging. Avoid covering important information.

Soft Home:

- Always default to large sticker or Hangtag.
- Avoid covering important information.
- Test adherence to any packaging or materials with known adhesion challenges.
- Product packaged in a retail box or package should have the sticker applied on the back and nearest to the top of the box or package.
- If the product is open stock and has a hangtag, add a supplemental RFID hangtag on the same loop/attachment as the existing UPC/Retail hangtag if there is no integrated hangtag available for your product.
- If the product is open stock and has a sticker that has a UPC/Retail price add a supplemental RFID sticker adjacent to the UPC sticker. If the product will be displayed on a fixture at Belk, stickers placed on the back of the package should be affixed next to the top of the package

Hard Home:

- Always default to large sticker.
- Avoid covering important information.
- Test adherence to any packaging or materials with known adhesion challenges.
- Do not place a RFID sticker directly on a metal surface. Metal products should use a RFID hangtag, or a sticker placed on a non-metal surface, like a bellyband or cardboard. If you have questions about whether your product is compatible with RFID tags or stickers, please reach out to Fabian Blanco at Avery Dennison fabian.blanco@averydennison.com. Product packaged in a retail box or package should have the sticker applied on the back and nearest to the top of the box or package.
- If the product is open stock and has a hangtag, add a supplemental RFID hangtag on the same loop/attachment as the existing UPC/Retail hangtag if there is no integrated hangtag available for your product.



- If the product is open stock and has a sticker that has a UPC/Retail price add a supplemental RFID sticker adjacent to the UPC sticker.

Please review additional tag placement options in alignment with the [GS1 Apparel and General Merchandise Placement Standards](#) (Section 4)

DO NOT COVER:

1. Barcodes.
2. Description fields such as style, color, size.
3. Validate that all stickers adhere securely to packaging.

****General rule for Packaged Apparel, Soft and Hard Home:** To avoid contact with fixtures/dividers in stores, and to improve RFID tag performance and readability, please place RFID stickers on the back of the package next to the top of the package.

RFID/EPC tickets are to be attached only to the primary garment of multi-piece, attached sets. All Vendors must apply the necessary quality control measures to ensure that the RFID tag/sticker is applied properly to all products.

A chargeback will be issued on products that were found with missing RFID stickers or tags. For the rate of chargeback, please refer to the chargeback table within this document.

6.10.5 Storage and Handling for RFID

Follow the listed storage & handling guidelines for RFID:

- RFID tags are recommended to store at temperature 15C to 25C , humidity 65% - 85%.
- RFID operating temperature range is -25C to 70C.
- Whenever possible, store RFID labels and tags in the original packaging and/ or anti-static bags until opened for use, to avoid ESD (electrostatic discharge).
- Keep at least 10M away from high voltage machinery or generators with over 600V.
- Avoid placing tag on metal, e.g., metal hanger clips.
- Avoid folding, bending, crushing of the tag.
- Data retention for RFID labels and tags can be 10+ years under proper conditions.
- Storage should be indoors, similar to non-RFID tags.
- Vendors should handle RFID tag with reasonable cares.
- RFID tag can pass through metal detectors and will not cause any problem.

Section Seven: Shipment Preparations

7.1 Carton Packing Requirements

All merchandise must be packed in conveyable cartons for shipment to Belk.

- Do not use plastic bags as the external shipping container. Do not use hanger packs (except Men's and Women's Suits and Sportscoats).
- Use a shipping carton that fits the merchandise. Merchandise should be packed 1/4 inch below the top of the carton and 1/8 inch from the sides of the carton. Cartons should be large enough to allow hangers to lie squarely in the carton.
- Each carton must contain merchandise for only one purchase order and only one store destination.
- Where possible, use biodegradable and recyclable packing materials.

- Cartons should be securely sealed with tape. Do not band cartons together nor use banding to secure cartons.
- Cartons should have a minimum strength of 32 ETC (edge test crush).
- All shipping cartons must be strong enough to withstand several further reshipments as individual cartons throughout the Belk supply chain.

7.2 Carton Dimensions

In order for cartons to efficiently move through Belk facilities, vendors must comply with the below dimensions and weight requirements. The below dimensions are what Belk considers as conveyable; any other sizes need to be pre-approved by the Belk Transportation Team. Note that the carton requirements are different for eCommerce / Store 888 orders.

ALL STORE ORDERS		
Dimension	Minimum	Maximum
Length	12"	36"
Width	12"	26"
Height	2"	30"
Weight	2 lbs	49 lbs

ALL ECOMMERCE ORDERS (STORE 888)		
Dimension	Minimum	Maximum
Length	12"	30"
Width	9"	24"
Height	6"	18"
Weight	2 lbs	49 lbs

7.3 Carton Labels

All cartons shipped to Belk require a GS1-128 shipping carton label. The GS1-128 should be included in the ASN transmission and contain a human readable 20 digit code. Below is the format required.

FROM Good Time Supplier 1155 Battery St. San Francisco, CA 94111	TO BELK DIST. CENTER #737 120 BELK COURT BLYTHEWOOD, S.C. 29016
SHIP TO POST (420) 29016	CARRIER BEST FREIGHT PRO: 289576880 BL: 853930
PO: 122639706 DEPT: 827 FOB: SHOES	
FOR (91) 0074	MARK FOR: 0074
SSCC-18 (00) 0 0052177 513895717 2	



- The vendor is responsible for ensuring that the GS1-128 tickets are able to be scanned.
- Labels must be a minimum of 6 inches high and 4 inches wide.
- The SSCC-18 bar code should be at least 1.26” in height and 3.0” wide.
- Family of Business (FOB) categories are as follows: Women’s, Men’s, Shoes, Kids, Home, and Center Core. If unsure of the correct FOB, confirm with the Belk buyer.
- Only store numbers should appear in the “MARK FOR” section of the carton label. Do not place
- the Distribution Center number or consolidation point numbers in this field.
- On the longest side of the carton, place the carton label in the lower right corner two (2) inches from the right side and bottom of the carton. Place the label on top of cartons under 4” in height. If the longest side of the carton is too short for the entire GS1-128 label to fit, put label on longest side and fold over the top of the carton.
- If merchandise is to be displayed on the sales floor in the carton in which it is packaged, the GS1-128 label should not interfere with or cover the product information contained on the carton.
- Each carton label must be affixed to the carton in such a manner to withstand the normal in-transit wear and tear.
- Vendors are to put a colored sticker, colored piece of tape, or colored marking on the top of all cartons. Stickers should be applied according to the color guidelines below by product category:
 - White - Accessories/Jewelry / Other Center Core
 - Red - Women’s
 - Orange - Home
 - Yellow – Kids
 - Green – Shoes
 - Light Blue – Men’s
 - Purple - Intimates
 - Black – Cosmetics and Fragrances

74 Material Restrictions

Do not use excessive packing materials inside the carton (cardboard, air pillows, inserts, foam pieces) and be environmentally conscious of how merchandise is packed.

- Packing peanuts are not allowed.
- Cardboard inserts are acceptable.
- Do not band the outside of the carton. No bands of straps of any kind are allowed.
- Shrink wrap around cartons is ok, but it cannot interfere with the GS1-128 label.

Section Eight: Shipping Standards

8.1 Ship Date Expectations

The purchase order provides a shipping window with a not before date and a not after / cancel date. Vendors are to ship all orders within the designated window. If vendor cannot ship within the designated ship window, then it is the vendor’s responsibility to reach out to the Belk Buyer for an extension on their purchase order shipping window, prior to shipping. Vendors will face a chargeback if the order is not shipped within the ship window on the purchase order. If a shipment is being temporarily held by a vendor past the cancel date, they must still request ship date extensions to avoid chargeback.



8.2 ASN Standards

Accurate ASN information should be transmitted at the time the shipment is picked up by the carrier. It is required that an ASN is sent at the shipment level, not the PO level.

- If a shipment is ready with a pickup date scheduled, the ASN data can be transmitted up to 7 days prior of the physical ship date.
- The ship date in the ASN should be the scheduled pickup date, not the date the ASN data is transmitted.
- For collect shipments the ASN must use the Transplace ME# as the BOL#.
- If the ASN is not available to the DC at the time the shipment reaches the facility, the vendor is subject to a “Late ASN” chargeback.
- If the ASN is not available to the DC by the time the shipment is processed, then the vendor will receive a “Missing ASN” chargeback.
- The ship date for all Belk documentation and compliance will be the ship date on the ASN, regardless of the physical/actual ship date.
- If an ASN requires a correction, the file must be resent as an original (BSN01 = 00) and the document ID must stay the same (BSN02 = ASN#), just use a new ISA control#, and the new transmission will overwrite the previous version in our system. Never reuse an ASN# (BSN02) for different shipments, as the system will process the file as a revision and overwrite the previous received data.
- Please reference the [EDI document](#) on Belk.com under Vendor Resources.

8.3 Ship One Time Per Purchase Order

All purchase orders are to be shipped with no more than one shipment made against a specific purchase order per destination DC. The purchase order is expected to be shipped in one shipment.

8.4 Shipment of Hazardous Materials

Vendors must reach out to Belk_Logistics@Transplace.com to alert the Belk Transportation department that a shipment with hazardous materials is on the way. Vendors are expected to know and follow industry standards for shipping hazardous materials.

8.5 Port of Entry Shipments

Belk does not currently support any Port of Entry Shipments. The vendor must be prepared to ship prepaid all the way to the proper DC. The vendor would be responsible for landing the container, clearing customs, draying, and transporting the container to the proper Belk DC for unloading. The vendor must bear all risks associated with the container, including delay, loss, damage, and demurrage.

8.6 Bill of Lading (BOL) Requirements

Collect Shipments:

Use of Transplace BOL is mandatory.

Please contact Belk_compliance@belk.com if exception is needed.

A complete and accurate BOL is required at the time of carrier pickup. Signatures, trailer # and seal # must be present.

Please avoid handwritten modifications to POs on BOL. Any shipment changes (PO additions, weight/cube/carton or pallet count adjustments) should be made in TMS prior to shipping so an updated BOL can be downloaded from TMS and provided to the carrier at pickup.



Prepaid Shipments:

All Bills of Lading must include the following information: total carton count per PO, total weight, BOL Number, NMFC item number and applicable class. For LTL shipments pallet count should also be noted on BOL. Vendors do not need to route through Transplace Transportation Management System.

- BOLs must have the following information at the time of loading: appointment time, driver time in, driver time out and driver/vendor signature.
- The BOL number presented with the physical shipment must be the exact BOL number reflected in all EDI documents.
- A BOL must accompany all shipments to include the supplemental pages and must contain a list of all valid purchase order numbers within the shipment. If any shipment arrives at a Belk facility without the BOL and without a complete list of all purchase order numbers and the respective carton quantity for each within the shipment, Belk will request from the vendor a copy of the BOL to include all supplemental pages with purchase order numbers.
- Prepaid shipments do not need to be routed in Belk's TMS. If a live unload appointment is needed, please reach out to DC contacts below and provide carton count, PO # and delivery date/time. ASN must be present upon arrival.

Blythewood - 737ApptRequests@belk.com

Jackson - 744ApptRequests@belk.com

Direct to store:

Shipments sent directly to a Belk store are not permitted unless approved in writing by Belk Buyer.

Section Nine: Routing Guide

9.1 Transportation Managements System and TMS Vendor Sup Up

Vendor merchandise shipments must be routed to Belk distribution facilities through Transplace's online TMS portal. Collect vendors who require access to TMS or need to have an additional ship location added, should contact Belk_Logistics@Transplace.com for set up.

A URL address and login ID will be provided to access the following TMS portals:

- **Transplace Order Management System (OMS):** to check PO status, route POs
- **Transplace External Shipment Monitoring portal:** to view load status/carrier assignment, download BOL and update select shipment quantities

9.2 Routing Requirements

All collect POs must be routed through TMS and assigned a Transplace Load# and carrier before vendor can ship. Any unauthorized shipments are subject to chargeback.

Routing Timeline:

Routing requests must be submitted no less than three business days prior to the expected ship date. All requests submitted after 12pm local time will be considered received the next business day. For example:

- If shipment has an expected ship date of Monday, TMS entry must be submitted no later than 12pm local time on the Wednesday beforehand.
- If shipment has an expected ship date of Thursday, TMS entry must be submitted no later than 12pm local time on the Monday beforehand.



The below chart outlines the proper timeline for submitting your routing request:

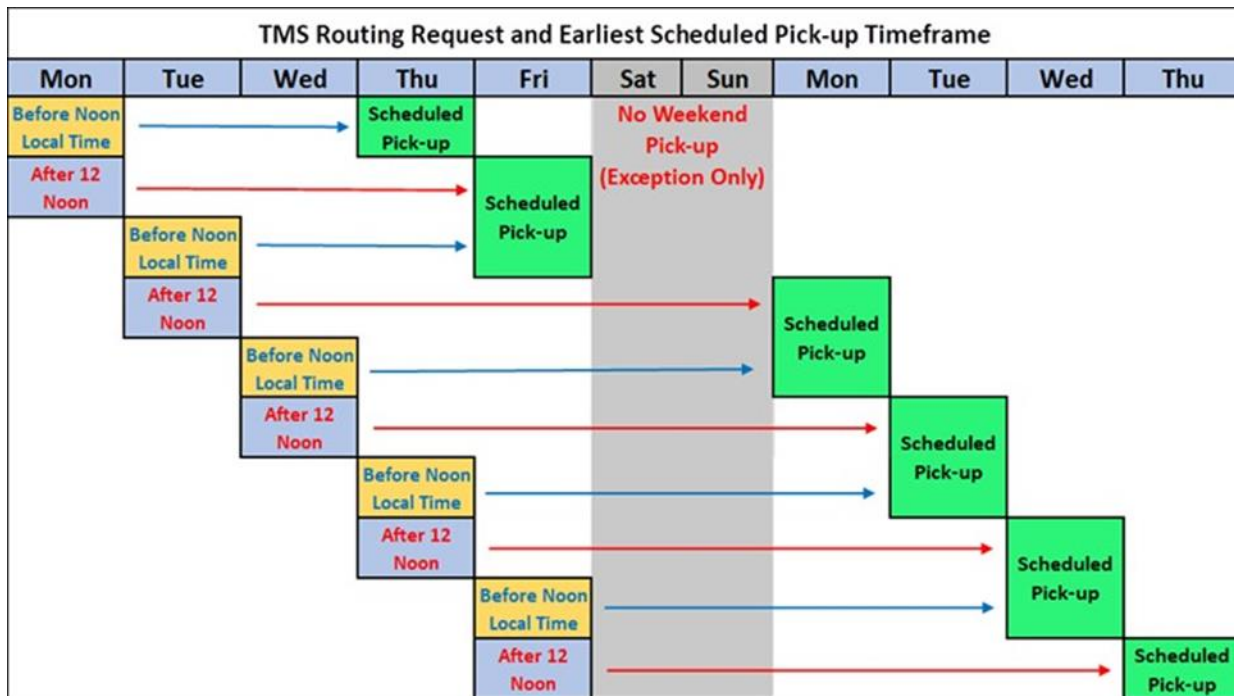

Routing Request standards:

- Vendors must provide accurate carton count, unit count, cube and weight for each PO when routing. Cube/weight estimates should be based on the floor loaded product.
- Routing request should not exceed truckload quantity (3500 cube and 43,000 lbs).
- If PO will exceed 1 truckload, vendor should create an additional routing requests for the balance of the PO.
- The following can be used for calculating cubic feet: Multiply length by width by height and divide the total number by 1,728 (total cubic inches per cubic foot).
- Any POs that will be shipping to the same DC within the same ship window should be consolidated into truckload quantities when routing. Please reference the [Vendor Quick-Step Routing Guide](#) for additional instruction on multi-PO release.
- Requested pickup dates must be on normal business days – Monday through Friday and must be within the PO ship window. Ready date should be at least 1 day prior to cancel date.

Parcel Shipments

FedEx Ground shipments must be shipped using the “FedEx Collect” program. FedEx Collect is a payment method provided to a FedEx customer in which the consignee has agreed to pay all of the shipping charges associated with a specific shipment. Vendors must ship the package using vendor’s FedEx account number and then the charge will be reversed to Belk upon receipt of the carton. In addition, the reference field of every carton must contain the Transplace BOL #/ Load # supplied to you by the Transportation Management System. Omission of the Transplace BOL # will result in a chargeback.



Palletization

LTL Shipments

- Belk policy requires the use of pallets for LTL shipments only (see requirements below).
- For shipments assigned to LTL mode types (including consolidation), vendor must update their pallet count and pallet weight via TMS 'Shipment monitoring portal'. This must be updated 24 hours prior to pick up date. Failure to add pallet count in TMS will result in chargeback.
- The vendor is still held to the Shipper Load and Count (SLC) standards and will be responsible for shortages on pallets noted with carton count Said to Contain (STC) in a shrink-wrapped pallet. This policy applies to all modes of transport.

Pallet Requirements

- Use 48"x 40" or 48" x42" pallets
- Must ship on 4-way access wooden pallets
- Must ship on grade B or higher pallets

Build Pallets

- No overhang permitted
- Avoid creating pallets over 5' and under 8'. Vendor can create pallets at 8' if it is packaged safely for transportation.
- Best practice is to create pallets less than 5' in height and to create two 48" pallets and double stack them
- Product should be double stacked unless merchandise is breakable. Vendor is responsible for any damages due to palletization
- A single DC destination per pallet
- Pallets must be stretch wrapped

Pallet Label Requirements

Each pallet must be labeled containing

- DC location
- x of x total pallets (per DC)

Truckload & Intermodal Shipments

- Belk policy prohibits the use of pallets for truckload and intermodal shipments unless prior written authorization is given by belk_logistics@transplace.com for each shipment
- If pallet approval is obtained, vendor should route POs in TMS including pallet weight.
- The vendor is still held to the Shipper Load and Count (SLC) standards and will be responsible for shortages on pallets noted with carton count Said to Contain (STC) in a shrink-wrapped pallet. This policy applies to all modes of transport.

9.3 Shipment Charges

- Vendors will have access to update the following fields in the External shipment monitoring portal: unit quantity, handling unit, weight, and cube.
- Adjustments to packaging unit (carton count) can be made in the Transplace OMS portal.
- Any shipment adjustments that will result in a mode change will need to be emailed to Belk_Logistics@Transplace.com.

- Vendors cannot make any changes to 'Earliest Time', 'Latest Time' or 'Pick up Address' after PO release. Vendor should contact Belk_Logistics@transplace.com if adjustments are needed.
- Transplace will review any changes that result in an 'error' status.
- Any POs to be added to an existing shipment will need to be entered as a new release. Vendor can request that the PO be added to a specific shipment by including the Transplace BOL#/ Load # in the comment section when releasing new PO.
- If overflow occurs when loading, please reach out to belk_logistics@transplace.com so shipment can be adjusted to reflect POs and quantities that were loaded. Any overflow will need to be re-routed and assigned a new Load #.

Shipping/Carrier Assignment

- Carrier assignment and load status can be viewed in the 'External Shipment Monitoring' portal.
- Vendors are only permitted to ship with an assigned carrier if the load is in 'tender accept' status.
- Routing instructions should not be considered if your load is in an un-planned status of 'pending', 'assigned', 'tendered', or 'tender reject'.
- Loads that are shipped with an unauthorized carrier will be subject to chargeback.
- It is the vendor's responsibility to schedule a pickup appointment with Belk's assigned carrier immediately. Any problems with carrier pick up should be reported to Belk_Logistics@Transplace.com.
- If freight will not be ready on the scheduled pick-up date, vendor will be responsible for reaching out to Belk's assigned carrier to reschedule pick-up. Please note, carrier must be notified at least 24 hrs prior to scheduled pick date or fee may apply.
- If the assigned carrier schedules a pick up date outside of PO ship window, please notify Belk_Logistics@transplace.com, Belk_compliance@belk.com and buyer.
- Chargebacks will apply for any cartons that are shipped to the wrong distribution center. Please refer to the store to DC mapping guide.

https://staging-web-belk.demandware.net/on/demandware.static/-/Sites-Belk-Library/default/dwa7a18fcd/media/pdf/VendorResources/Whats_New/StoreShippingReceivingLocations_Blythewood6_21_21.pdf

<https://staging-web-belk.demandware.net/on/demandware.static/-/Sites-Belk-Library/default/v67f01dbd236b297211ef21e296219fc6e3f3b594/media/pdf/VendorResources/Transportation/ByramShippingandReceivingLocations021819.pdf>

9.4 Transportation Vendor Expense Sharing

To maintain competitive freight costs, Belk requires all vendors to ship to Belk distribution centers from the nearest vendor distribution point. Due to higher freight costs of shipping across the country, vendors shipping from west of the Mississippi river or outside of the 48 contiguous states will share half of the total freight expense.

In addition, Belk utilizes a freight consolidator to minimize freight costs. Belk encourages all vendors to consolidate shipments as much as possible from the origination point. If, however the vendor's shipment is routed through a consolidator (CA and areas surrounding NJ), vendor will be charged the

smaller consolidation cost while Belk will cover the higher full freight cost from the consolidation point to Belk's distribution centers.

Both of these expense sharing charges will be listed on the payment remittance as a freight chargeback deduction.

Section Ten: Returns to Vendor

10.1 Damaged Merchandise

Damage allowances will be taken off invoice per the vendor's agreement with the Belk merchandising team. If there is not a damage allowance as part of the vendor agreement, then damaged merchandise will be returned to the vendor and freight charges will be assessed.

10.2 Defective Merchandise

Merchandise that is deemed to be sub-standard and / or not according to the product specification agreed upon with the Buyer will be returned to the vendor and inbound and outbound freight charges.

10.3 Unsold Merchandise

Seasonal and stock adjustment returns will be determined by the Belk merchandising team and negotiated with the vendor on an as needed basis.

10.4 Returns to Vendors

Belk does not consolidate returns to vendors. All returns will be shipped via Fed Ex, as they are received at the DC from store locations. Vendor pick up and company account numbers for Fed Ex or UPS are not allowed.

Section Eleven: Accounts Payable

11.1 Invoices

Invoices should be submitted via the EDI 810 document. The Belk EDI 810 invoice must be consolidated by Belk Distribution Centers, one invoice per DC location per purchase order.

- If not already certified for EDI invoicing, do not begin transmitting the EDI 810 document until the testing process is complete.
- Invoices must include the vendor UPC number. If the purchase order is for a pre-pack, then the pre-pack UPC should be on the invoice, not the component UPCs.
- Original invoices should be transmitted by EDI. Do not send copies, screen prints, or duplicate invoices unless requested. Do not send order confirmations, packing slips, or BOL to the Belk A/P center.

11.2 Terms and Conditions of Payment

Vendors will be paid according to the terms agreed upon with the Belk merchandising team.

- For payment terms of End Of Month (EOM), goods shipped or invoiced on or after the 25th of the month are not considered due until the 10th of the following month (e.g., an invoice with terms of 8/10 EOM for goods which were invoiced/received on March 25, 2017 would have a payment due date of May 10, 2017). In addition, Belk selects the most beneficial payment terms based on the terms contained on the master file, on the purchase order, or on the vendor's invoice.



- Memo vendors should not send Belk merchandise invoices for Memo merchandise. One week after each fiscal month, the memo vendor will receive a sales report from Belk accounts payable showing by SKU all memo merchandise sold, net returns, for the period covered in the report. Memo vendors are paid weekly based on the negotiated terms with the Belk Buyer.
- Vendors will be paid according to the terms agreed upon with the Belk merchandising team. However, all vendor obligations (including, without limitation, vendor allowances and chargebacks) (collectively, “Vendor Obligations”) earned and due to Belk will be processed against vendor invoices within the same fiscal quarter. If Belk is unable to recover the Vendor Obligation within the fiscal quarter earned against vendor invoices, vendor reimbursement to Belk will be required to resolve the situation within 30 days of end of the fiscal quarter in which the Vendor Obligation is earned. This policy applies to all vendor obligations negotiated between the Belk merchandising team and the Vendor and supersedes any other verbal agreements on when Vendor Obligations will be processed against invoices.

11.3 Accounts Payable Vendor Web Portal

The Belk vendor portal can be found at <https://vendorportal.belk.com/VendorPortal/> . The vendor web portal should be used as the primary source to answer all chargeback and payment inquiries. The portal will provide important vendor information including check information, details of current trial balance, the status of an invoice, vendor adjustments, return packing slips along with tracking information, and all chargeback deductions. The portal requires a 12-digit account number to log in, please contact VCG@Belk.com to be set up for access.

Section Twelve: Vendor Chargebacks

Please review the contact information by reason code in the Reason Code List located in the Vendor Portal:

<https://staging-web-belk.demandware.net/s/Belk/customer-service/about-us/vendor-resources/>

12.1 Chargeback Table

CODE	CHARGE DESCRIPTION	CHARGE
PRODUCT INFORMATION		
50	GXS item set up not completed 2 weeks prior to Belk order deadline	\$10 per SKU
50	Incorrect NRF color and / or size code used	\$10 per SKU
50	UPC number recycled earlier than allowed	\$10 per SKU
50	GXS item / pre-pack set up information (including UPC number) changed after order entry	\$10 per SKU
50	GXS extended attributes not entered 8 weeks prior to ship	\$10 per SKU
49	Sample or image not received 8 weeks prior to ship	\$250 per sample / image
104	Late receipt of First Fit sample	\$100 per sample



105	Late final fit approval	\$100 per style
106	Missing or unauthorized party for product testing	\$500 per occurrence
121	Late receipt of Ad/Ecom sample	\$100 per sample
107	Missing or unauthorized party for final inspection	\$500 per occurrence
PURCHASE ORDER SHIPMENTS		
82	No order on file / Shipped without a valid PO	\$25 per store per PO
96	Store not on PO	\$25 per carton
88	Not ordered / substituted SKU shipped	\$25 per carton + 10% of total cost
90	Shipped Early	\$25 per store per PO
97	Shipped Past Cancel	\$25 per store per PO
89	Quantity received in excess of quantity ordered for store	\$25 per carton + 10% of total cost
48	PO not shipped once and complete	\$500 per PO per occurrence of additional shipments on same PO
103	Short shipment of greater than 5% of PO	5% of FOB
EDI / ASN INFORMATION		
75	Missing / unusable / incorrect ASN	\$10 per carton
36	Late ASN transmission	\$5 per carton
29	Incorrect ASN vs carton contents	\$5 per store per PO
67	Inaccurate SKU on ASN	\$5 per carton
PRODUCT PREPARATION		
80	Missing / incorrect / unscannable UPC ticket or incorrect ticket placement	\$25 per receipt and \$0.60 per unit, minimum \$50 per receipt
81	Missing /wrong retail	\$25 per receipt and \$0.60 per unit, minimum \$50.00 per receipt
84	Missing or unacceptable hanger / sizer / wrong hanger type	\$25 per receipt and \$0.60 per unit, minimum \$50 per receipt
101	Missing or Defective RFID, or RFID sourced from non-approved vendor	\$25 per receipt and \$0.60 per unit, minimum \$50 per receipt
116	Hanger sourced through non approved vendor	\$500 per order
46	Missing size strip tape or sticker	\$25 per receipt and \$0.60 per unit, minimum \$50 per receipt

98	SKU from Different Vendor	\$7 per carton
99	Unknown UPC	\$7 per carton
ECOMMERCE PRODUCT PREPARATION		
52	eCommerce packaged incorrectly (missing polybag, missing label, or does not follow dept. specific directions)	\$250 per PO + \$1 per unit
53	eCommerce product shipped on hanger	\$250 per PO + \$1 per unit
55	eCommerce product not shipped in single SKU carton where required	\$250 per PO + \$.50 per unit
57	eCommerce product not shipped in reshippable single unit packaging as required	\$500 per PO + \$10 per unit
54	eCommerce product shipped in carton outside of minimum / maximum requirements	\$250 per PO + \$50 per carton
CARTON PREPARATION		
35	Cartons do not meet minimum / maximum conveyable dimensions or weight	\$2 per carton
37	Incorrect or missing PO#/store/dept on carton	\$10 per carton
56	Not packed separately by store or PO #	\$75 per carton
85	Missing / unscannable GS1-128 carton label or missing info on carton label	\$10 per carton
43	Carton sealed with excessive bands/straps/not sealed	\$10 per carton
45	Missing carton color code label	\$25 per store per PO + \$.25 per carton
58	Items shipped to store in individual polybags	\$20 per carton
SHIPPING AND TRANSPORTATION		
93	Unauthorized shipment or unauthorized carrier used	\$500 handling + full freight invoice amount
95	Shipped to wrong DC or location	\$125 handling per Distribution Center + \$10 per carton
68	BOL is unavailable or Transplace ME# not present on BOL for collect shipments	\$250 per Shipment
73	Inaccurate cube, weight, carton count, or PO#s listed on routing request	\$250 per shipment or \$250 handling + full freight invoice (charge will be determined based on cost impact to Belk)
59	Missing shipment ID in Fed Ex reference field	\$250 handling + full freight invoice amount
72	Routing request received after 12pm local time 3 business days prior to requested ship date	\$250 per routing request



74	Applicable to LTL Shipments only: failure to palletize shipment, pallet count incorrect, or unavailable in TMS	\$250 per Shipment
120	Unauthorized pallets for TL	\$250 per Shipment
79	BOL is incorrect or incomplete. BOL incomplete: missing signature, seal # or PO# BOL incorrect: wrong BOL for the load or erroneous data on BOL	\$250 per Shipment
118	Failure to provide Transplace load# in ASN	\$250 per Shipment
76	Expense sharing of 50% freight cost for shipments originating west of the Mississippi River	50% of full freight invoice amount
77	Expense sharing of consolidation costs	100% of consolidation charge from consolidator
27	Freight not available for pickup at confirmed Carrier appointment time	Missed appointment fee + \$250 handling
119	Detention Loading	\$250 handling + Full amount of fees assessed
94	Other transportation charges (accessorial fees that may include layover, additional miles, drop trailer, reweigh charge, etc.)	\$250 handling + full amount of fees assessed
INVOICES AND ACCOUNTS PAYABLE		
34	Invoice not sent via EDI 810	\$50 per invoice
40	Invoice not consolidated	\$25 per invoice
40	Invoice missing required information or contains inaccurate information	\$25 per invoice
41	Trade Discount	Agreed to Terms
102	Invoice sent prior to final ASN / Shipment	\$100 per occurrence
CHARGEBACK INQUIRIES		
25	Other – Accounts Payable Deduction	Will vary by claim type

12.2 Chargeback Inquiries and Disputes

Chargeback inquiry questions should be sent to Belk_Compliance@belk.com. The email will be acknowledged within 48 hours, but it may take up to 30 days to receive a response. Please note that Belk answers all inquiries on a first come, first serve basis. Any request for information that is available on the vendor web portal will incur a chargeback of \$50 per item per claim number to be researched. All vendor chargeback inquiries and disputes must be made within 6 months of shipment.



12.3 Chargeback Dispute Requirements

To dispute a chargeback, the dispute must include the following information in the email to Belk_Compliance@belk.com:

- Vendor name and number
- Purchase order number
- Debit memo number or invoice number
- Ship date
- Documentation and detailed explanation supporting dispute
- Contact name and number

Section Thirteen: Payment Information

13.1 Payment Remittance Details

To view remittance information, log on to the Vendor Portal at <https://vendorportal.belk.com/VendorPortal/>.

Here you will be able to reconcile payments by viewing invoices and any chargebacks or reversals that are included in a particular payment. If you have questions about the portal or need to receive your unique user # and secure pin, please email VCG@belk.com.

13.2 Outstanding Invoice Verification

To obtain a Vendor Trial Balance with all outstanding invoices in our system, please send an email to Expense_Payables@belk.com.

Section Fourteen: Key Contact Information

14.1 Belk Contact Information

Contact Group	Email
Vendor Onboarding Questions	Vendor_Relations@belk.com
Supplier Direct Fulfillment/Drop Ship Onboarding and Questions	SDFVendorCare@belk.com
Transportation and Routing Questions	Transportation_Services@belk.com
Vendor Compliance Requirements and Chargeback Questions	Belk_Compliance@belk.com
ASN Questions	ASN@belk.com
EDI Questions	EDI@belk.com
Accounts Payable Questions	AP_Corresponence@belk.com
Debit Balance Questions	Debit_Balance@belk.com
UPC Ticket Information	BSS_ICG@belk.com
Vendor Address or Information Maintenance	VCG@belk.com
Payment Portal Questions	VCG@belk.com
Invoice Questions	Expense_Payables@belk.com

Belk Mailing Address:

Belk Private Brands
2801 W. Tyvola Road Charlotte, NC 28217



MSDS for all Cosmetic/Fragrance Mailing Address:

Jonesville Fulfillment Center
Attn: BFC Loss Prevention
3805 Furman L Fendley Hwy
Jonesville, SC 29353

For FINE JEWELRY & What Goes Around Comes Around – PO Receipts and Shipping Address:

Jackson Processing Center
Attention: Door 72
1018 Mendell Davis Drive
Jackson, MS 39272

For Fulfillment/ECOM PO Receipts & Shipping Address:

Jonesville Fulfillment Center
Building B (745)
3805 Furman L Fendley Hwy
Jonesville, SC 29353

For FINE JEWELRY – Repairs, Returns and Damages Shipping Address:

Jackson DC – Repair & Returns Center (746)
1018 Mendell Davis Drive
Jackson, MS 39272

14.2 Belk Recommended Suppliers

GS1

<http://www.gs1us.org/get-started/im-new-to-gs1-us>

GXS-OPENTEXT UPC Catalog

Contact Tonia James - jtonia@opentext.com / (404) 467-3029

GS1 Size / Color Codes (formally NRF) – [Click here for more info on Size / Color Codes \(GS1\)](#)

Merchandise Ticket Recommended Vendors

Avery Dennison
WFL Packaging
r-pac



Appendix A: Terms and Conditions of Purchase Order

The following terms and conditions apply to all purchase orders issued by Belk for products ordered from any supplier (each, a "Purchase Order"). Belk is referred to below as "Purchaser" and supplier is referred to as "Vendor."

1. Vendor agrees that it will not ship merchandise under this Purchase Order earlier than the "Ship" date no later than the "Cancel" date hereof. Purchaser reserves the right to refuse (including at the carriers' facilities) or return any merchandise that is shipped prior to the "Ship" date or after the "Cancel" date or that is substituted, over-shipped, or not ordered hereby. Purchaser assumes no risk or expense on any merchandise refused or returned for nonconformance with the terms and conditions of this Purchase Order. All refusals or merchandise returns for nonconformance will be subject to a deduction on remittances of all applicable freight charges plus an expense offset charge as indicated on the Belk chargeback table or in the Belk Private Brands Domestic Importer Vendor Business Requirements. If Purchaser elects to keep shipments shipped prior to the "Ship" date, terms will be computed from the "Ship" date shown here on. If Purchaser elects to keep shipments shipped after the "Cancel" date, terms will be computed from the actual date of the shipment, Purchase Order "Ship" date or date of invoice, whichever is later; and the foregoing expense offset charge as indicated on the Belk chargeback table or in the Belk Private Brands Domestic Importer Vendor Business Requirements.
2. Purchaser must be notified in writing within 5 days of Purchase Order issuance if this Purchase Order is not accepted, including all terms and conditions as stated therein.
3. Purchaser reserves the right, without penalty, to cancel any purchase order, in whole or in part, in the event that Purchaser's use of the merchandise is prevented, hindered, or delayed by or during the period of a force majeure event or circumstance outside of Purchaser's control, including without limitation any fire, flood, earthquake, epidemic, pandemic (including, but not limited to, COVID-19 and any voluntary or mandated mitigation measures with respect thereto), government action, riot, strike, war and/or other force majeure event.
4. It is understood that Purchaser shall have a reasonable time and opportunity to examine the merchandise included in this Purchase Order when received in its store, whether or not its agents have previously examined said merchandise, and, if it shall then be ascertained that said merchandise or any part thereof is not in conformity with this Purchase Order or is not as represented or warranted by Vendor, is inferior in workmanship or quality or is otherwise defective, or is delivered in a damaged condition (other than damaged in transit), Purchaser shall have the right to rescind this contract and return all or any part of the merchandise to Vendor at Vendor's expense, plus a charge as indicated on the Belk chargeback table or in the Belk Private Brands Domestic Importer Vendor Business Requirements, if said conditions are determined during the receiving process. If said conditions are discovered at any time after the receiving process has been completed, the merchandise may be returned at Vendor's expense. The right to rescind given hereunder shall not be construed as a limitation on the right to rescind or other rights given by







common law or statute. As used herein, the term "Vendor's expense" shall mean inbound and outbound freight costs plus the cost of any transit insurance associated therewith.





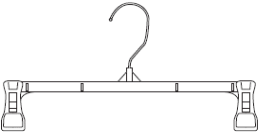

5. Vendor shall be responsible for including all applicable sales, use or excise taxes in its purchase price. In the event a statutory exemption applies, Belk shall be responsible for providing a valid exemption certificate to the vendor.
6. By acceptance of this Purchase Order, Vendor agrees to:
 - A. Deliver all merchandise in accordance with this Purchase Order at the prices stated herein or at such lower prices and at any better terms and discounts as may be prevailing at the time of shipment.
 - B. Guarantee that all merchandise ordered has been priced, stamped, labeled, tagged, marked, invoiced, and delivered in full compliance with (i) all applicable international, federal, state, and local government (and all departments, boards, bureaus and commissions thereof) laws, rules, standards, orders, rulings, rules, guides and regulations, including, but not limited to the Federal Trade Commission Act, the Consumer Product Safety Act, the Transportation Recall Enhancement, Accountability, and Documentation Act, the Textile Fiber Products Identification Act and regulations relating to statement of fiber content of rayon, wool, linens, and other textiles contained in such merchandise, the Wool Products Labeling Act, the Care Labeling Rule, the Fair Packaging and Labeling Act, the Magnusson-Moss Warranty Act, the Federal Hazardous Substances Act, the Poison Prevention Packaging Act, the Radiation Control for Health and Safety Act, the Food, Drug and Cosmetics Act, California Proposition 65, and the Fur Products Labeling Act, and (ii) the laws, regulations and rules of all countries in which merchandise is produced or delivered. Vendor shall provide to Belk any information that is required to be displayed in order to comply with laws applicable to eCommerce sales of the merchandise [including but not limited to any California Proposition 65 warnings].
 - C. Guarantee that all merchandise ordered hereunder has been or will be manufactured, compounded, or produced in full compliance with (i) all applicable international, federal, state, and local government labor laws, rules, and regulations, specifically including, without limitation, all applicable minimum wage, overtime, and child labor laws, rules, and regulations, and (ii) the Belk Private Brands Code of Conduct.
 - D. Warrant to Purchaser and its customers that such merchandise is free from defects of workmanship and material and is fit for normal use by the consumer.
 - E. Defend, indemnify and hold Purchaser harmless from and against all claims, damages, losses, liabilities, and expenses (including reasonable attorneys' fees) on account of:
 - (1) Any actual or alleged defect in the merchandise ordered hereunder;
 - (2) Any actual or alleged patent, copyright, trade secret, or trademark or other intellectual property infringement arising from Vendor's manufacturer, sale, or export, or Purchaser's use, sale, or offering for sale, of any merchandise ordered hereunder;

- (3) Purchaser's and Purchaser's customers' reliance upon the warranties set out in B, C, and D above; and
 - (4) Any gross negligence, willful misconduct, fraud, or violation of law by Vendor or any of its suppliers.
 - (5) Any unfair competition.
 - (6) Any unfair or deceptive trade practices in connection with the merchandise and/or the product content furnished by Vendor to Belk.
 - (7) Personal injuries or other damages sustained by any person from the use or misuse of the merchandise.
 - (8) Any claim of strict liability, negligence, recklessness, or willful misconduct on the part of Vendor and/or relating to the merchandise.
7. Purchaser reserves the right to take immediate credit for all goods that are to be returned to Vendor because they do not meet the requirements of this Purchase Order.
 8. Purchaser reserves the right to dispose of Vendor's goods at Purchaser's option, in such manner as Purchaser deems appropriate, if any return authorization is not received by Purchaser from Vendor within 30 days of original request.
 9. No assignment or other transfer of this Purchase Order, by Vendor, to any third party, will operate to create any liability by Purchaser hereunder to any such third party without the prior written consent of Purchaser to such assignment or transfer; provided, however, that nothing hereinabove contained shall be deemed to prohibit the Vendor's subcontracting, to one or more third parties, the production of part or all of the merchandise ordered hereunder.
 10. If any provision of this Purchase Order, specifically including any provision contained in the following Billing and Shipping Instructions, shall be construed, or held to be invalid or unenforceable by any court of governmental body or agency having jurisdiction thereof, then this Purchase Order will be interpreted as though such provision had been omitted, and the validity and enforceability of the remaining provisions hereof will be valid, enforceable, and unaffected thereby.
 11. No modification of or addition to these terms and condition shall be affected by any course of dealing or usage of trade, or acceptance or acknowledgement by Vendor of any Purchase Order or other form submitted by Vendor containing additional or different terms or conditions. Purchaser and Vendor may only modify these terms and conditions by a clear and conspicuous written amendment or agreement signed by both parties that expressly states the intent of the parties to modify these terms and conditions.



12. This agreement shall be controlled, construed, and enforced in accordance with the laws of the State of North Carolina. Purchaser and Vendor hereby consent to the jurisdiction of the federal and state courts in Mecklenburg County, North Carolina, in connection with any dispute between the parties hereto and each waives any objection based on improper or inconvenient venue.

Appendix B: Hanger Specifications

	Standard Hanger Code	Size	SIZER	Color	Size Zone
Top I-Beam Hanger with Metal Hook					
	BEL-484	17"	NONE	Black	Missy/Petite/Mens/YC
	BEL-479	19"	NONE	Black	Plus/B&T
Top Knit Wear Hanger (Non-Slip) - Sweater Products Only					
	BEL-584	17"	NONE	Black	Missy/Petite/Mens/YC
	BEL-579	19"	NONE	Black	Plus/B&T
Bottom Padded (2 side) Clip Hanger					
	BEL-6212	12"	NONE	Black	Missy/Petite/Mens/YC
	BEL-6214	14"	NONE	Black	If needed
	BEL-6216	16"	NONE	Black	Plus/B&T
Outerwear					
	BEL-3329	17"	NONE	Black	Missy/Petite/Mens/YC
	BEL-3320	19"	NONE	Black	Plus/B&T
Intimate Apparel					
	BEL-GS-19	10"	NONE	Clear	Missy/Petite/Plus

	Standard Hanger Code	Size	SIZER	Color	Size Zone
Bottom Pinch Clip Hanger - Separates					
	BEL-6108	8"	YES	White	Baby/Toddler (2T-4T)
	BEL-6110	10"	YES	White	Boys 4-7, Girls 4-6X
	BEL-6110B	10"	YES	Black	Boys 8-20, Girls 7-16
Bottom Pinch Clip Hanger, Sets - 4" drop					
	BEL-9408	8"	YES	White	Baby/Toddler (2T-4T)
	BEL-9410	10"	YES	White	Boys 4-7, Girls 4-6X
	BEL-9412	12"	YES	Black	Boys 8-20, Girls 7-16
Bottom Pinch Clip Hanger, Sets - 7" drop					
	BEL-6908	8"	YES	White	Baby/Toddler (2T-4T)
	BEL-6910	10"	YES	White	Boys 4-7, Girls 4-6X
Set Hanger, 2 piece set - 4" drop					
	BEL-410	10"	YES	White	Baby/Toddler (2T-4T)
	BEL-429	12"	YES	White	Boys 4-7, Girls 4-6X
Set Hanger, 2 piece set - 7" drop					
	BEL-420	10"	YES	White	Baby/Toddler (2T-4T)
	BEL-422	12"	YES	White	Boys 4-7, Girls 4-6X
Set Hanger, 3 piece set - 3" drop					
	BEL-4410	10" top 7" bottom	YES	White	Baby/Toddler (2T-4T)
	BEL-4412	12" top 8" bottom	YES	White	Boys 4-7, Girls 4-6X

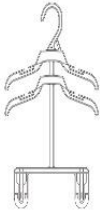
	Standard Hanger Code	Size	SIZER	Color	Size Zone
Top Hanger with Notches - Separates					
	BEL-495	10"	YES	White	Baby/Toddler (2T-4T)
	BEL-496	12"	YES	White	Boys 4-7, Girls 4-6X
	BEL-472B	15"	YES	Black	Boys 8-20, Girls 7-16

	Standard Hanger Code	Size	SIZER	Color	Size Zone
Set Hanger, 3 piece set - 6" drop					
	BEL-2110	10" top 8" bottom	YES	White	Baby/Toddler (2T-4T)
	BEL-2112	12" top 8" bottom	YES	White	Boys 4-7, Girls 4-6X
Outerwear					
	BEL-3316	15"	NONE	Black	Boys 8-20, Girls 7-16
Sizer					
	BEL-S83 BEL-ST1 -VICS				ALL KIDS
	<p>**follow GS1 US Color to Size Cross-Reference https://www.gs1us.org/DesktopModules/Bring2mind/DMX/Download.aspx?Command=Core_Download&EntryId=420&language=en-US&PortalId=0&TabId=134</p>				

Appendix C: Example of Store Packing

Please see the below example of how to pack items for store orders correctly. All orders are for stores unless designated as eCommerce / Store 888 on the purchase order.



1. Hang garments on rack, and bundle in groups of 4-6



2. Use a carton with one master poly bag lining the box. DO NOT use poly bags for each individual garment.

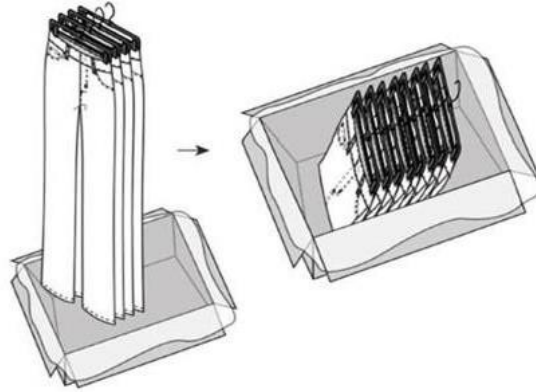

3. Lower each bundle straight down into the carton allowing the pants to scunch until the garments are inside the box with hangers on top. Seal the master poly bag after all bundles are inside the carton to avoid moisture damage during transit.

Appendix D: Reshippable Carton Requirements

Single Wall Box Strength Guidelines			
Max Weight (lbs)	Size Limit (L+W+H)	Min Burst Test	Min ETC
30	75"	200	32
40	75"	200	40
50	85"	250	44
65	95"	275	55
80	105"	350	N/A
Double Wall Box Strength Guidelines			
Max Weight (lbs)	Size Limit (L+W+H)	Min Burst Test	Min ETC
60	85"	200	48
80	95"	275	51
100	105"	350	61
120	110"	400	71
140	115"	500	82
150	120"	600	N/A

Appendix E: Ecommerce Folding Guidelines

Sweaters, Shirts, Blouses, Coats, Jackets, Blazers, Activewear

- Lay garment with back facing up.
- Fold back sleeves, fold backside, fold in half (front to back)
- Place the garment in bag with as much of the garment showing as possible.
- The collar of the garment should be placed at the end of the bag.
- Fold and seal or tape the flap on the back of the bag.
- Place a UPC Barcoded Sticker on polybag as discussed in the eCommerce requirements.

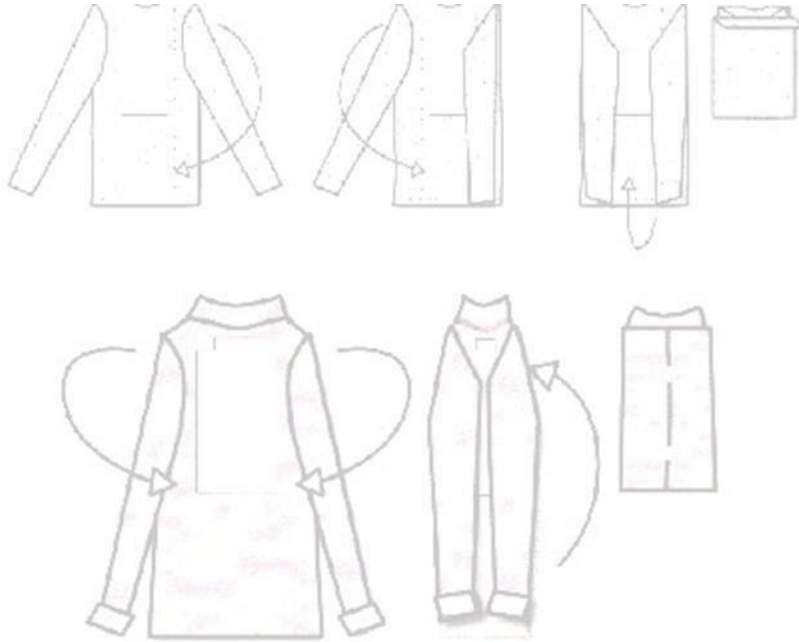

Pants

- Garment should be held at the waist and facing the person folding. Place hands at the center of the waist and pull apart.
- Lay garment on its side.
- Fold the back legs to the center. Fold the back waist to the center. Fold into thirds whenever possible.
- Slide the merchandise into the polybag waist first.
- Fold and seal or tape the flap on the back of the bag.
- Place a UPC Barcoded Sticker on polybag as discussed in the eCommerce requirements.

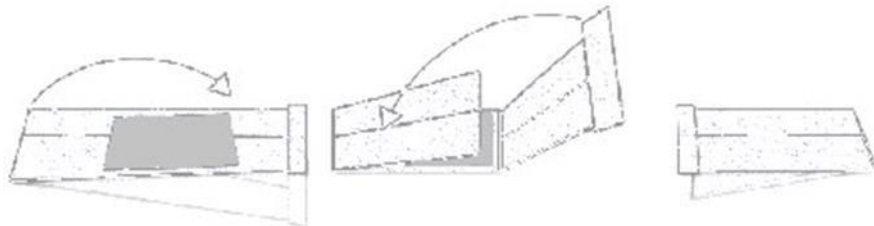

Skirts

- Lay the skirt with the back facing up.
- Fold in the sides, then fold bottom to top.
- Slide the merchandise into the polybag waist first.
- Fold and seal or tape the flap on the back of the bag.
- Place a UPC Barcoded Sticker on polybag as discussed in the eCommerce requirements.

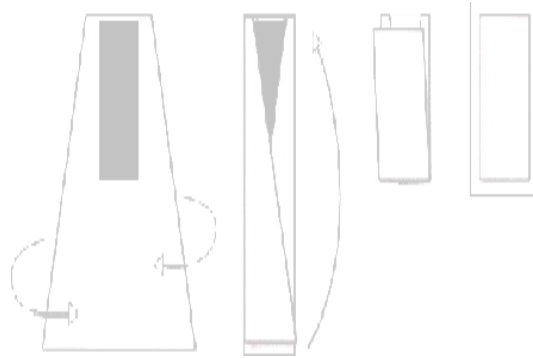

Dresses and Slips

- Lay the Dress / Slip down with the back facing up.
- Fold back the sleeves. Fold the sides in. Fold the bottom of the dress up.
- Any collar must show and be placed face up.
- Fold and seal or tape flap on the back of the bag.
- Place a UPC Barcoded Sticker on polybag as discussed in the eCommerce requirements.

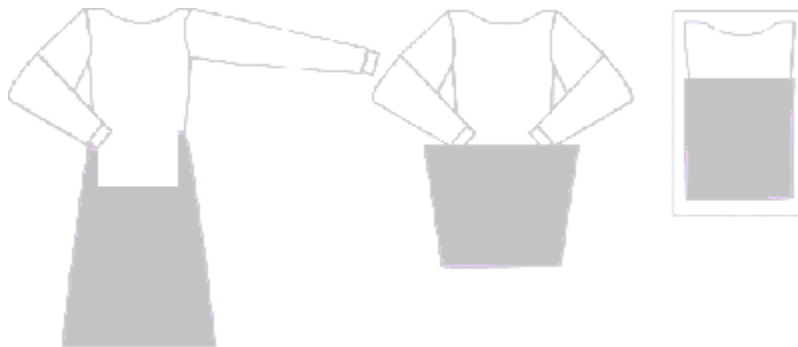

Appendix F: Vendor & Factory Profile



MODERN. SOUTHERN. STYLE.

Date: _____

Vendor Name: _____

Vendor Address: _____

Contact Name: _____

Contact Title: _____

Contact email: _____

Agent: _____	Direct: Yes or No	Domestic Importer: Yes or No
--------------	-------------------	------------------------------

List other U.S. Retailers as customers: _____

Factory Name Country of Production

1. _____

2. _____

3. _____

4. _____

5. _____



Appendix G: Vendor Recordkeeping Requirements

REASON FOR THE PROCEDURES

Belk International acts as the importer of record (IOR) for purchase orders (POs) that are placed with international vendors, either directly or through Belk's agents.

As the importer of record, Belk International is responsible for U.S. Customs and Border Protection (CBP) requirements. US CBP has authority to review records made or normally kept in the ordinary course of business. CBP is authorized to review documentation related to:

1. Any importation into the U.S.
2. Transportation into the U.S.
3. Use of Free Trade Agreements (FTA)
4. Any other activity administered by the US CBP

Below you will find a detailed list of documentation that should be available for each Belk International Purchase Order (PO) to import merchandise into the US or used to substantiate the use of FTAs. This documentation must be provided to Belk within fifteen (15) days of request to meet the time restraints that US CBP allows for advising.

Belk will periodically conduct documentation or production records audits with vendors utilizing FTAs to ensure compliance with these procedures.

Records should be maintained for 5 years from the date of entry into the United States.

Failure to maintain appropriate recordkeeping requirements can result in fines and penalties by US CBP.

Additional information regarding recordkeeping requirements is located at the following website:
<https://www.cbp.gov/document/publications/recordkeeping>

RECORDS

The following list includes records which are required to be kept on file by law or regulation. These records may be required by CBP to substantiate importation into the US or valuation of a product. Not every PO will require all of the following information. Only the records applicable to each PO are required.

1. Purchase Order
2. Bill of lading or air waybill
3. Commercial invoice – includes date, number, description of merchandise, quantities, values, unit price, trade terms, part, model, style, markets and numbers, name and address of foreign party responsible or invoicing, kind of currency
4. Packing list
5. Terms of sale
6. Shipping quantities
7. Shipping units of measurements
8. Documents required for entries of GSP merchandise, GSP declaration; if applicable
9. AGOA Textile Certificate of Origin and supporting records; if applicable
10. Other Free Trade Agreement documentation or certificates of origin; if applicable
11. APHIS documents
12. Single country declaration
13. Multiple country declaration
14. Product testing files
15. VISA



16. Certificate of origin
17. Production records

FREE TRADE AGREEMENTS (FTA)

CBP has the authority to request documentation to substantiate the use of FTAs. This section applies to any Purchase Orders where Belk is claiming duty free treatment as a result of an FTA

Every Belk supplier working with the production of product eligible for duty free treatment or reduced duty under a Trade Preference Agreement should maintain a procedure manual detailing the regulations applicable and processes necessary to be eligible for the benefits of the related FTA. Documentation should be available regardless of single or multiple country of origin. This includes:

1. Utilization of any Free Trade Agreement (FTA) for imports into the U.S.
2. Invoices of all materials used in production, including, but not limited to: fabric, yarns, trims.
3. Shipping documents from raw material suppliers to production factory
4. Clearance documentation of raw materials into country of production and any applicable government import licenses

Proof of Production

Timeline

A detailed and concise timeline prepared by the factory outlining chronological dates and details of events as they occurred. Dates should include fabric purchase, cut parts, et. al.

Materials

1. Invoices of all materials used in production, including, but not limited to: fabric, yarns, trims.
2. Shipping documents from raw material suppliers to production factory
3. Clearance documentation of raw materials into country of production and any applicable government import licenses
4. Documentation on labels or other materials incorporated into item produced

Production Records

The below information should be provided by country:

1. Internal factory production order
2. Cutting records if fabric is purchased from mill. Cutting records should include verification of quantity, color and size of order
3. List of number and types of machinery available at production factory
4. List of number and types of machinery utilized in production of Belk PO
5. Time cards of employees involved in production order with highlights of times employee worked on the Belk PO
6. Assembly records including records maintained on the factory floor, detailing the operations performed, employees performing said operations and the dates the operations were performed
7. Proof of factory operation during time of production (i.e. power/electric bill)
8. All shipping details documenting movement
9. Proof of export from country of export

Subcontractor Records

All details listed in section 3.1.3 of this document should be provided for any sub-contractor used to product Belk POs.

Inspection Certificates

1. In-line inspection reports
2. Final inspection report

Appendix H: Mainetti Contact List

Global Account Manager – USA:

Tim Hourihan
E: timothy.hourihan@mainetti.com
Tel: 732-675-3411

Bangladesh

Zunaid S Ahmed
E: zahmed@bengal.com.bd
Tel: +880 2 222 288 248 ~ 249

Central America

Ricardo Romero
E: r.romero@salvaplastic.com.sv
Tel: +(503) 2511 3400

India

Shobha Sureshkumar
E: shobha.sureshkumar@mainetti.com
Tel: +91 44 4293 8030

Philippines

Jo Chen
E: lexanhangers@pltdsl.net
Tel: +(63) 2 366 0928

Vietnam / Singapore

Michael Vo
E: michael.vo@mainetti.com
Tel: +84 28 3823 8776

Global Account Manager – Asia (HK)

Iris Tang
E: iris.tang@mainetti.com
Tel: +852 2950 1679

Cambodia

Aizhen
E: bopha@jinjincambodia.com
Tel: + 855 23 315 608

China

Vivian Chen
E: vivian.chen@mainetti.com
Tel: +86 21 5128 0828 - 238

Indonesia

Angie Murti
E: angie.murti@mainetti.com
Tel: +62 21 7504504

Taiwan

Paul Wu
E: paulwu@kkindustrial.com
Tel: 886- 2-2303-5115 / 2-2305-6676

Appendix I: RFID Tag and Sticker Catalog











Integrated RFID Tag and Sticker Catalog
Updated 8.30.2021



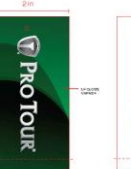
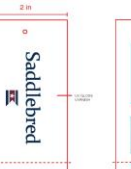





NEW TAG CODE/FILENAME	BRAND	THUMBNAIL	TYPE	CATEGORY	AVAILABLE TO ORDER DATE	NOTES
BH21-HT-MAIN-HM-RFID	BILTMORE HOTEL		HANG TAG	HOME	9/10/2021	
BILT21-HT-MAIN-HM-RFID	BILTMORE		HANG TAG	HOME	9/1/2021	
CI21-HT-CAB-RFID	CABANA		HANG TAG	APPAREL	9/1/2021	
CI21-HT-MAIN-HM-RFID	CROWN & IVY		HANG TAG	HOME	9/1/2021	
CI21-HT-MAIN-RFID	CROWN & IVY		HANG TAG	APPAREL	9/1/2021	
CI21-JT-MAIN-RFID	CROWN & IVY		JOKER TAG	APPAREL	9/1/2021	Please be sure that AD has the correct Program Name for the tag when you place your order



CT21-HT-MAIN-HM-RFID	COOK'S TOOLS		HANG TAG	HOME	9/1/2021	
GEN21-HT-MAIN-HM-RFID	GENERIC		HANG TAG	HOME	9/1/2021	To be used when a generic hangtag is needed with the UPC / Retail Price for Home products
GEN21-HT-MAIN-RFID	GENERIC		HANG TAG	APPAREL	9/1/2021	To be used when a generic hangtag is needed with the UPC / Retail Price for apparel products
GG21-HT-MAIN-HM-RFID	GOODNESS & GRACE		HANG TAG	HOME	9/1/2021	
GG21-HT-MAIN-RFID	GOODNESS & GRACE		HANG TAG	APPAREL	9/1/2021	
JL21-HT-MAIN-HM-RFID	JOYLAND		HANG TAG	HOME	9/1/2021	
JL21-HT-MAIN-RFID	JOYLAND		HANG TAG	APPAREL	9/1/2021	
JL21-STK-HM-RFID	JOYLAND		STICKER	HOME	10/15/2021	To be used on all JOYLAND ornaments

KR21-HT-MAIN-RFID	KIM ROGERS		HANG TAG	APPAREL	9/1/2021	
KR21-JT-MAIN-RFID	KIM ROGERS		JOKER TAG	APPAREL	9/1/2021	Please be sure that AD has the correct Program Name for the tag when you place your order
LIB21-HT-MAIN-RFID	LIBERTY PARK		HANG TAG	APPAREL	9/1/2021	
LIM21-HT-MAIN-RFID (Limited is a Varnish)	LIMITED		HANG TAG	APPAREL	9/1/2021	
MAD21-HT-MAIN-RFID	MADISON		HANG TAG	APPAREL	9/1/2021	
MAD21-JT-MAIN-RFID	MADISON		JOKER TAG	APPAREL	9/1/2021	Please be sure that AD has the correct Program Name for the tag when you place your order
MSH21-HT-MAIN-HM-RFID	MSH		HANG TAG	HOME	9/1/2021	
OC21-HT-MAIN-RFID	OCEAN + COAST		HANG TAG	APPAREL	9/1/2021	
OC21-JT-MAIN-RFID	OCEAN + COAST		JOKER TAG	APPAREL	9/1/2021	Please be sure that AD has the correct Program Name for the tag when you place your order

PAR21-HT-MAIN-RFID (Parisian tag is a 2-Part Tag; this is for the back tag)	PARISIAN		HANG TAG	APPAREL	9/1/2021	Will be paired with a front Parisian Hangtag that does not carry any product specific information
PAR21-JT-MAIN-RFID	PARISIAN		JOKER TAG	APPAREL	9/1/2021	Please be sure that AD has the correct Program Name for the tag when you place your order
PT21-HT-MAIN-RFID	PRO TOUR		HANG TAG	APPAREL	9/1/2021	
SB21-HT-MAIN-RFID	SADDELBRED		HANG TAG	APPAREL	9/1/2021	
SB21-JT-MAIN-RFID	SADDELBRED		JOKER TAG	APPAREL	9/1/2021	Please be sure that AD has the correct Program Name for the tag when you place your order
TC21-HT-MAIN-RFID	TRUE CRAFT		HANG TAG	APPAREL	12/1/2021	
TOT21-HT-MAIN-RFID	TEAM OF TINY		HANG TAG	APPAREL	9/1/2021	
WON21-HT-MAIN-RFID	WONDERLY		HANG TAG	APPAREL	12/1/2021	
ZEL21-HT-MAIN-RFID	ZELOS		HANG TAG	APPAREL	9/1/2021	

BELK21-STK-ROUND-HM-RFID	BILTMORE HOTEL JOYLAND GOODNESS & GRACE MODERN SOUTHERN HOME MODERN SOUTHERN HOME ESSENTIALS CROWN & IVY COOK'S TOOLS		STICKER	HOME	10/30/2021	Logo on sticker will change for each brand
BELK21-STK-UPC-LG-RFID	GENERIC		STICKER	HOME	10/30/2021	To be used on Home products as needed
BELK21-STK-UPC-SM-HM-RFID	GENERIC		STICKER	HOME	9/25/2021	To be used on Home products as needed only when the large sticker will not fit product / packaging
BELK21-STK-UPC-SM-RFID	GENERIC		STICKER	APPAREL	9/25/2021	To be used on Apparel products that require a generic non-brand specific sticker
BELK21-TA-UPC-RFID	GENERIC		TEARAWAY LABEL	HOME	9/20/2021	To be used on all towels, washcloths, hand towels, and any other bath product that has a tearaway UPC
BELK21-RFID-BARCD-ACCS-STR Integrated RFID XSmall Sticker	GENERIC		STICKER	FASHION JEWELRY	Currently Available	Should only be used on Fashion Jewelry and Accessory Products where a larger sticker cannot fit on the packaging / header / backer card.
BELK21-RFID-HANGTAG Supplemental RFID Hang Tag	GENERIC		HANG TAG	SUPPLEMENTAL	Currently Available	Should only be used if there is no integrated RFID UPC hangtag format available for use. Must be used in conjunction with another hangtag that has the UPC / Retail price. Use on Apparel, Handbags, Accessories, Home, and Jewelry products where the UPC / Retail is on a hangtag.
BELK21-RFID-LG-STR Supplemental RFID Large Sticker	GENERIC		STICKER	SUPPLEMENTAL	Currently Available	Should only be used if there is no integrated RFID UPC sticker format available for use. Must be used in conjunction with another sticker that has the UPC / Retail price. To be used on Home, Accessories, Footwear products where the UPC / Retail is on a sticker.
BELK21-RFID-SM-STR Supplemental RFID Small Sticker	GENERIC		STICKER	SUPPLEMENTAL	Currently Available	Should only be used if there is no integrated RFID UPC sticker format available for use. Must be used in conjunction with another sticker that has the UPC / Retail price. To be used on Home, Accessories, Footwear products where the UPC / Retail is on a sticker and the size of the product cannot accommodate the large sticker above.

